



Laxco Microscope Systems

- SeBa™ Digital Imaging Systems
- LMC Series Upright Microscopes
- LMI Series Inverted Microscopes
- LMS Stereo Microscopes
- Illumination Systems

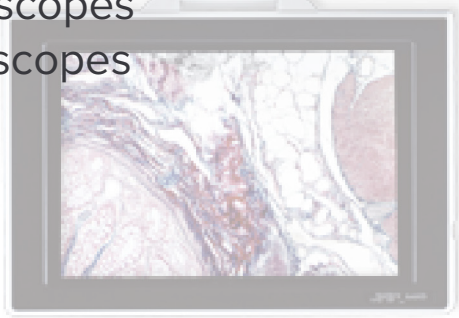

TABLE OF CONTENTS

BF/PH/DF/DIASCOPIC	SeBa™ SERIES	EDUCATION
SeBa™ Series 4-13	SeBa2™ Series 4-5	LMC-1000 Series 14-17
LMC-1000 Series 14-17	SeBa3™ Series 6-7	LMC-2000 Series 18-19
LMC-2000 Series 18-19	SeBaP4™ Series 8-9	
LMC-3000 Series 20-21	SeBaP4B™ Series 10-11	
LMC-4000 Series 22-23	SeBaP5™ Series 12-13	
LMC-5000 Series 30-31		
LMI-6000 Series 36-37		
MZS4 Series 56-57		
MZS32 Series 58-59		

FLUORESCENCE	RESEARCH/CLINICAL
LMC-3000 Series 20-21	LMC-3000 Series 20-21
LMC-4000 Series 24-25	LMC-4000 Series 22-29
LMC-5000 Series 32-33	LMC-5000 Series 30-35
MZS33 Series 60-61	

POLARIZATION	INVERTED
LMC-4000 Series 26-27	LMC-6000 Series 36-37

REFLECTED LIGHT	BASIC STEREO
LMC-1000 Series 14-15	MS Series 38-39
LMC-4000 Series 28-29	MZS1 Series 40-41
LMC-5000 Series 34-35	MZS2 Series 42-43
	D10 Series 44-45
	T10 Series 48-49

DISSECTING	ILLUMINATION	ADVANCED STEREO
T10 Series 48-49	LED Series 63	MZS4 Series 56-57
T40 Series 46-47	FOS Series 62	T40 Series 46-47
A10 Series 54-55		MZS32 Series 58-59
BM300 Series 50-51		MZS33 Series 60-61
BM500 Series 52-53		A10 Series 54-55
		BM300 Series 50-51
		BM500 Series 52-53



Environmentally Friendly

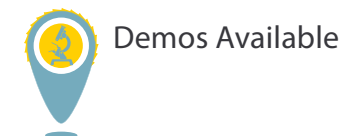

Demos Available



Custom Filter Options



UV SAFE



*SEBA™ 2 FOR EDUCATION

- BRIGHTFIELD
- PHASE CONTRAST
- CROSS POLARIZATION
- DARKFIELD TO 40X
- OPTIONAL
- Still Images
- Video Recording
- SeBaShare
- Wifi
- 5MP Color Camera
- USB Storage
- LED Illumination
- Infinity Corrected
- 4 Port USB 2.0 Connectivity
- Carrying Handle
- 9.7" Color Touchscreen Retina Display



UPLOAD YOUR IMAGES TO THE CLOUD!

SeBa™ changes the way you view your microscope by simplifying the complexities of a traditional microscope. Its seamless integration of camera, computer and monitor creates an easy to use, all-in-one digital microscope that is perfect for any environment. SeBa™ brings collaboration, teaching, routine scanning, and image documentation into the next generation!

KEY FEATURES

- 4 position objective nosepiece
- 9.7" full retina touchscreen display
- 5MP color camera
- Individual user login via access card(s)
- Easily capture, review, measure, print, and annotate images
- Brightfield, darkfield, simple polarization, & phase contrast
- Upload images to SeBaShare or save to USB drive
- User-friendly touchscreen interface
- Parfocal, parcentric, infinity plan achro optical system

*SEBAACCESS™

CAPTURE...
CLOUD...
COLLABORATE...

SeBaAccess™ allows a user to automatically log into their own unique SeBaShare™ account by simply placing their SeBaAccess™ card up against the SeBa logo on the front SeBa head. The SeBa star's green LED will light up, and a toast will pop up at the bottom of the scan to indicate you have successfully logged in. Once logged in, simply click on the SeBaShare™ icon to upload that image to the SeBaShare™ account for later retrieval or viewing.



Measure

- Capture
- Save
- Annotate
- Radius
- Angle
- Area
- Line Segment
- Cross Measure
- Cont Line Segment
- Perpendicular
- Point-to-Point

SIMPLE, SEAMLESS INTEGRATION

CAT. NO.	HEAD	OBJECTIVES	OPTICS	FOV	FOCUS CONTROLS	KOEHLER	CONDENSER	ILLUM	STAGE	OBJ TURRET
SEBA2BF1	SEBA	4X, 10X, 40X, 100X Oil	INF, PLAN ACH	20MM	COARSE & FINE	FULL	1.25 N.A. ABBE, WITH IRIS AND PHASE/DARKFIELD SLOT	3W LED	X/Y MECHANICAL	4 POS
SEBA2PH1	SEBA	10XPH, 20XPH, 40XPH, 100XPH Oil	INFINITY, PLAN ACH PHASE	20MM	COARSE & FINE	FULL	1.25 N.A. ABBE, WITH IRIS AND PHASE/DARKFIELD SLOT	3W LED	X/Y MECHANICAL	4 POS
SEBA2DF1	SEBA	4X, 10X, 40X, 100X Oil	INFINITY, DARKFIELD	20MM	COARSE & FINE	FULL	1.25 N.A. ABBE, WITH IRIS AND 4-40 DARKFIELD SLIDER	3W LED	X/Y MECHANICAL	4 POS
SEBA2PL1	SEBA	4X, 10X, 40X, 100X Oil	INFINITY, CROSS POL	20MM	COARSE & FINE	FULL	1.25 N.A. ABBE, WITH IRIS AND PHASE/DARKFIELD SLOT	3W LED	X/Y MECHANICAL	4 POS



*SEBA™ 3 FOR ROUTINE CLINICAL OR EDUCATION



UPLOAD YOUR IMAGES TO THE CLOUD!

SeBa™ changes the way you view your microscope by simplifying the complexities of a traditional microscope. Its seamless integration of camera, computer and monitor creates an easy to use, all-in-one digital microscope that is perfect for any environment. SeBa™ brings collaboration, teaching, routine scanning, and image documentation into the next generation!

KEY FEATURES

- 5 position objective nosepiece
- 9.7" full retina touchscreen display
- 5MP color camera
- Individual user login via access card(s)
- Easily capture, review, measure, print, and annotate images
- Brightfield, darkfield, simple polarization, & phase contrast
- Upload images to SeBaShare or save to USB drive
- User-friendly touchscreen interface
- Parfocal, parcentric, infinity plan achro optical system

*SEBAACCESS™

CAPTURE...
CLOUD...
COLLABORATE...

SeBaAccess™ allows a user to automatically log into their own unique SeBaShare™ account by simply placing their SeBaAccess™ card up against the SeBa logo on the front SeBa head. The SeBa star's green LED will light up, and a toast will pop up at the bottom of the scan to indicate you have successfully logged in. Once logged in, simply click on the SeBaShare™ icon to upload that image to the SeBaShare™ account for later retrieval or viewing.

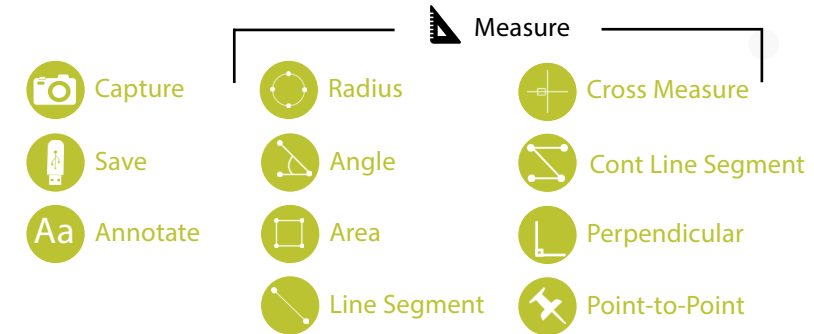
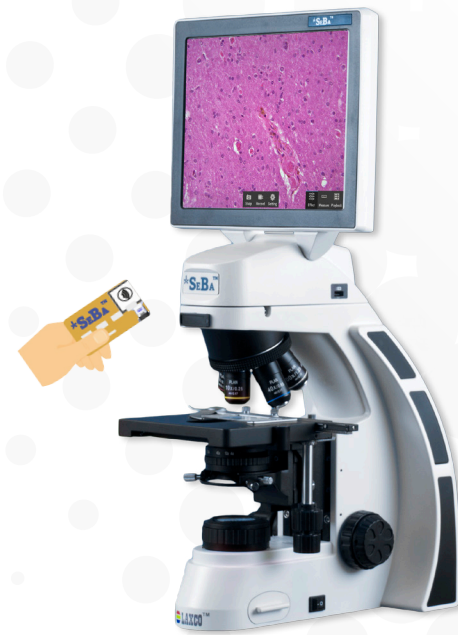

SIMPLE, SEAMLESS INTEGRATION

CAT. NO.	HEAD	OBJECTIVES	OPTICS	FOV	FOCUS CONTROLS	KOEHLER	CONDENSER	ILLUM	STAGE	OBJ TURRET
SEBA3BF1	SEBA	4X, 10X, 20X, 40X, 100X OIL	INFINITY	22MM	COARSE & FINE	FULL	1.25 N.A. ABBE, WITH IRIS AND PHASE/DARKFIELD SLOT	3W LED	X/Y MECHANICAL	5 POS
SEBA3PH1	SEBA	4x, 10XPH, 20XPH, 40XPH, 100XPH OIL	INFINITY, PHASE	22MM	COARSE & FINE	FULL	1.25 N.A. ABBE, WITH IRIS AND PHASE/DARKFIELD SLOT	3W LED	X/Y MECHANICAL	5 POS
SEBA3DF1	SEBA	4x, 10X, 20X, 40X, 100X OIL	INFINITY, DARKFIELD	22MM	COARSE & FINE	FULL	1.25 N.A. ABBE, WITH IRIS AND 4-40 DARKFIELD SLIDER	3W LED	X/Y MECHANICAL	5 POS
SEBA3PL1	SEBA	4x, 10X, 20X, 40X, 100X OIL	INFINITY, CROSS POL	22MM	COARSE & FINE	FULL	1.25 N.A. ABBE, WITH IRIS AND PHASE/DARKFIELD SLOT	3W LED	X/Y MECHANICAL	5 POS



*SeBa™ PRO 4 FOR CLINICAL OR RESEARCH

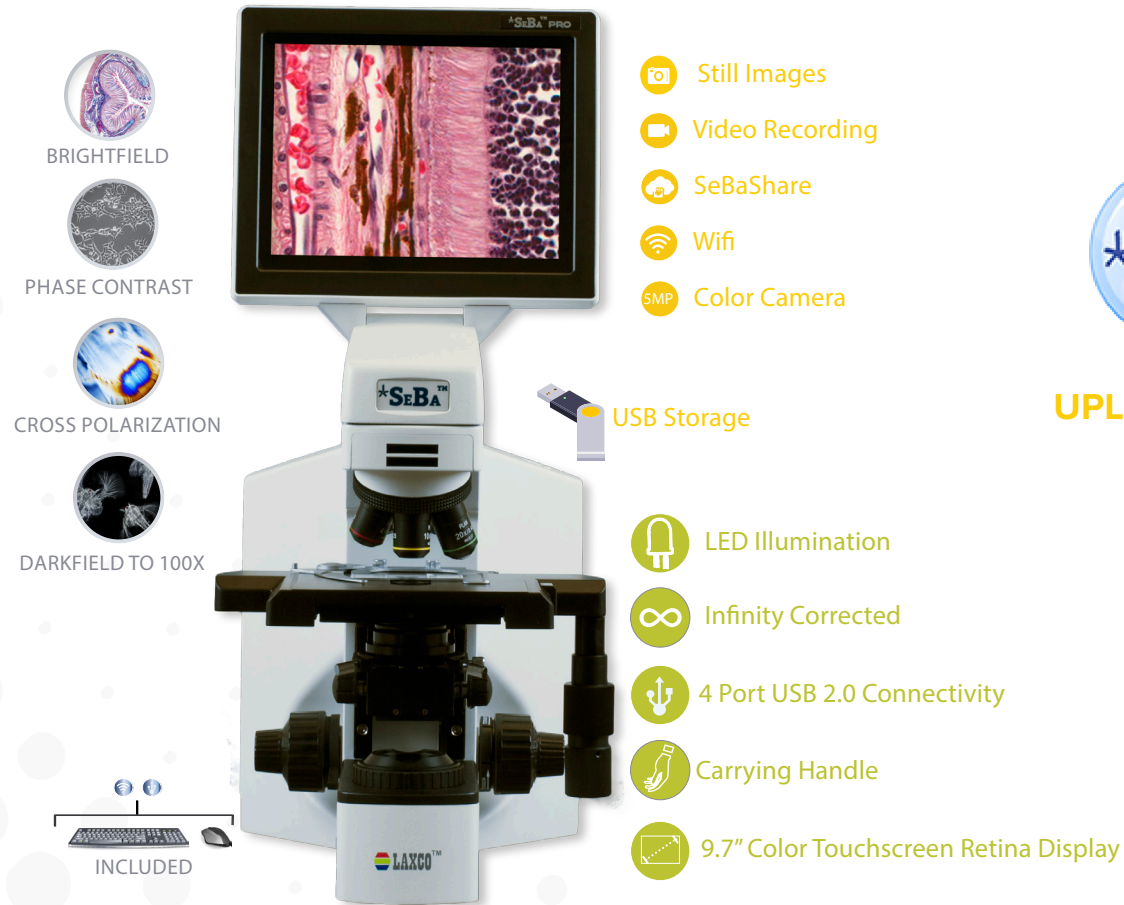

UPLOAD YOUR IMAGES TO THE CLOUD!

SeBa™ changes the way you view your microscope by simplifying the complexities of a traditional microscope. Its seamless integration of camera, computer and monitor creates an easy to use, all-in-one digital microscope that is perfect for any environment. SeBa™ brings collaboration, teaching, routine scanning, and image documentation into the next generation!

KEY FEATURES

- 5 position objective nosepiece
- 9.7", 2736 x 1824 retina display with 10 point multi-touch
- 16MP Color Camera
- Individual user login via access card(s)
- Easily capture, review, measure, print, and annotate images
- Brightfield, darkfield, simple polarization, & phase contrast
- Upload images to SeBaShare or save to USB drive
- Parfocal and parcentric infinity optical system
- Plan Achromat objectives standard, Plan Fluor (Optional)
- X/Y rackless wire-driven stage

*SeBaACCESS™

CAPTURE...
CLOUD...
COLLABORATE...

SeBaAccess™ allows a user to automatically log into their own unique SeBaShare™ account by simply placing their SeBaAccess™ card up against the SeBa logo on the front SeBa head. The SeBa star's green LED will light up, and a toast will pop up at the bottom of the scan to indicate you have successfully logged in. Once logged in, simply click on the SeBaShare™ icon to upload that image to the SeBaShare™ account for later retrieval or viewing.

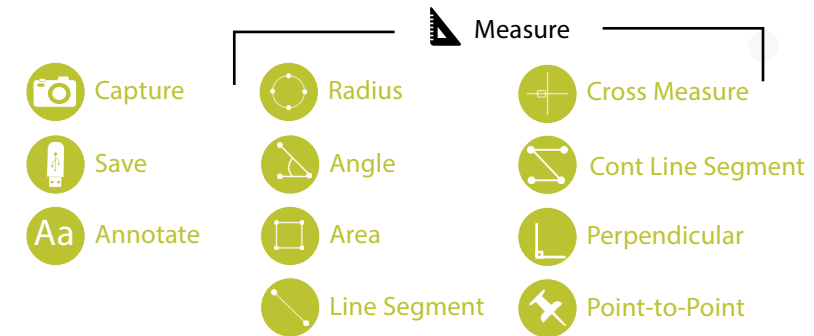
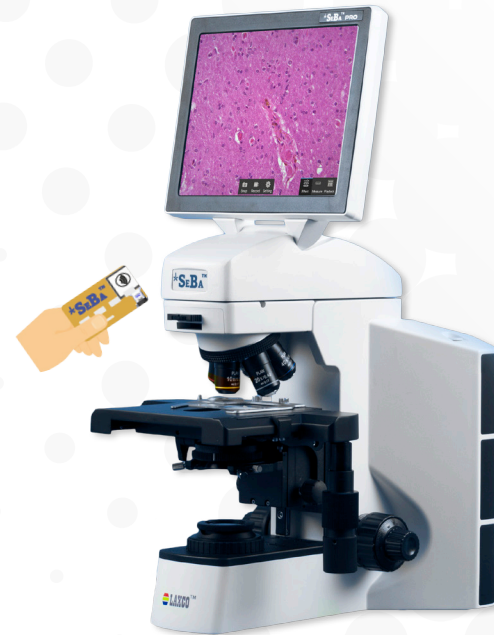

SIMPLE, SEAMLESS INTEGRATION

CAT. NO.	HEAD	OBJECTIVES	OPTICS	FOV	FOCUS CONTROLS	KOEHLER	CONDENSER	ILLUM	STAGE	OBJ TURRET
SEBAP4BF1	SEBA	4X, 10X, 20X, 40X, 100X Oil	INFINITY	22MM	COARSE & FINE	FULL	1.2 N.A. ABBE, WITH IRIS AND FLIP OUT LENS WITH 0.9 N.A.	5W LED	RACKLESS X/Y MECHANICAL	5 POS
SEBAP4PH1	SEBA	4x, 10XPH, 20XPH, 40XPH, 100XPH Oil	INFINITY, PHASE	22MM	COARSE & FINE	FULL	1.25 N.A. ABBE, 5-POSITION PHASE CONTRAST TURRET	5W LED	RACKLESS X/Y MECHANICAL	5 POS
SEBAP4DF1	SEBA	4x, 10X, 20X, 40X, 100X Oil	INFINITY, DARKFIELD	22MM	COARSE & FINE	FULL	1.25 N.A. ABBE, DARKFIELD Oil UP TO 100X	5W LED	RACKLESS X/Y MECHANICAL	5 POS
SEBAP4PL1	SEBA	4x, 10X, 20X, 40X, 100X Oil	INFINITY, CROSS POL	22MM	COARSE & FINE	FULL	1.2 N.A. ABBE, WITH IRIS AND FLIP OUT LENS WITH 0.9 N.A.	5W LED	RACKLESS X/Y MECHANICAL	5 POS



*SeBa™ PRO 4B FOR PATHOLOGY



- BRIGHTFIELD
- PHASE CONTRAST
- CROSS POLARIZATION
- DARKFIELD TO 100X

- Still Images
- Video Recording
- SeBaShare
- Wifi
- Color Camera
- USB Storage
- LED Illumination
- Infinity Corrected
- 4 Port USB 2.0 Connectivity
- Carrying Handle
- 9.7" Color Touchscreen Retina Display
- Light Path Shield



UPLOAD YOUR IMAGES TO THE CLOUD!

*SeBaACCESS™

CAPTURE...
CLOUD...
COLLABORATE...

SeBaAccess™ allows a user to automatically log into their own unique SeBaShare™ account by simply placing their SeBaAccess™ card up against the SeBa logo on the front SeBa head. The SeBa star's green LED will light up, and a toast will pop up at the bottom of the scan to indicate you have successfully logged in. Once logged in, simply click on the SeBaShare™ icon to upload that image to the SeBaShare™ account for later retrieval or viewing.

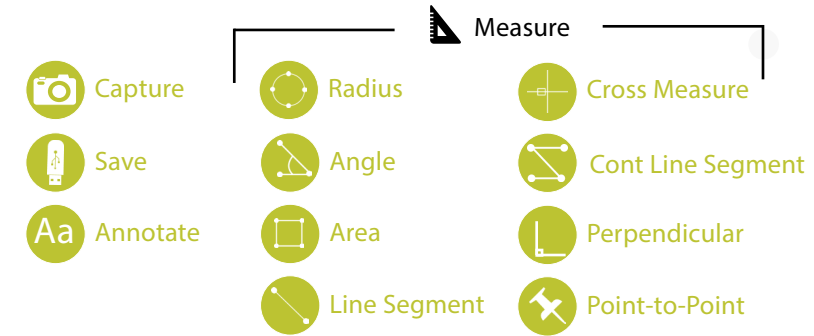

SIMPLE, SEAMLESS INTEGRATION

SeBa™ changes the way you view your microscope by simplifying the complexities of a traditional microscope. Its seamless integration of camera, computer and monitor creates an easy to use, all-in-one digital microscope that is perfect for any environment. SeBa™ brings collaboration, teaching, routine scanning, and image documentation into the next generation!

KEY FEATURES

- Binocular head with 22mm FOV 10x eyepieces
- 5 position objective nosepiece
- 9.7", 2736 x 1824 display with 10 point multi-touch
- 16MP Color Camera
- Individual user login via access card(s)
- Easily capture, review, measure, print, and annotate images
- Brightfield, darkfield, simple polarization, & phase contrast
- Upload images to SeBaShare or save to USB drive
- Parfocal and parcentric infinity optical system
- Plan Achromat objectives standard, Plan Fluor (Optional)
- X/Y rackless wire-driven stage

CAT. NO.	HEAD	OBJECTIVES	OPTICS	FOV	FOCUS CONTROLS	KOEHLER	CONDENSER	ILLUM	STAGE	OBJ TURRET
SEBAP4BBF1	SEBA-BINOC	4X, 10X, 20X, 40X, 100X Oil	INFINITY	22MM	COARSE & FINE	FULL	1.2 N.A. ABBE, WITH IRIS AND FLIP OUT LENS WITH 0.9 N.A.	5W LED	RACKLESS X/Y MECHANICAL	5 POS
SEBAP4BPH1	SEBA-BINOC	4x, 10XPH, 20XPH, 40XPH, 100XPH Oil	INFINITY, PHASE	22MM	COARSE & FINE	FULL	1.25 N.A. ABBE, 5-POSITION PHASE CONTRAST TURRET	5W LED	RACKLESS X/Y MECHANICAL	5 POS
SEBAP4BDF1	SEBA-BINOC	4x, 10X, 20X, 40X, 100X Oil	INFINITY, DARKFIELD	22MM	COARSE & FINE	FULL	1.25 N.A. ABBE, DARKFIELD OIL UP TO 100X	5W LED	RACKLESS X/Y MECHANICAL	5 POS
SEBAP4BPL1	SEBA-BINOC	4x, 10X, 20X, 40X, 100X Oil	INFINITY, CROSS POL	22MM	COARSE & FINE	FULL	1.2 N.A. ABBE, WITH IRIS AND FLIP OUT LENS WITH 0.9 N.A.	5W LED	RACKLESS X/Y MECHANICAL	5 POS



*SeBa™ PRO 5 FOR RESEARCH



BRIGHTFIELD

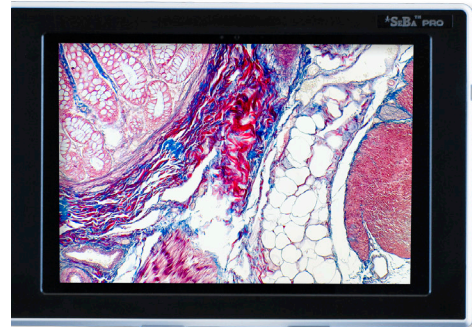

INCLUDED

- Still Images
- Video Recording
- SeBaShare
- Wifi
- Color Camera

USB Storage

- LED Illumination
- Infinity Corrected
- 4 Port USB 2.0 Connectivity
- Carrying Handle
- 9.7" Color Touchscreen Retina Display
- Light Path Shield



UPLOAD YOUR IMAGES TO THE CLOUD!

SeBa™ changes the way you view your microscope by simplifying the complexities of a traditional microscope. Its seamless integration of camera, computer and monitor creates an easy to use, all-in-one digital microscope that is perfect for any environment. SeBa™ brings collaboration, teaching, routine scanning, and image documentation into the next generation!

KEY FEATURES

- 6 position objective nosepiece
- 12.3", 2048 x 1536 display with 10 point multi-touch
- 16MP Color Camera
- Individual user login via access card(s)
- Easily capture, review, measure, print, and annotate images
- Brightfield illumination
- Upload images to SeBaShare or save to USB drive
- Parfocal and parcentric infinity optical system
- Plan Fluor objectives standard, Plan Achromat (Optional)
- X/Y rackless wire-driven stage
- Integrated LBD and ND filters

*SeBaACCESS™

CAPTURE...
CLOUD...
COLLABORATE...

SeBaAccess™ allows a user to automatically log into their own unique SeBaShare™ account by simply placing their SeBaAccess™ card up against the SeBa logo on the front SeBa head. The SeBa star's green LED will light up, and a toast will pop up at the bottom of the scan to indicate you have successfully logged in. Once logged in, simply click on the SeBaShare™ icon to upload that image to the SeBaShare™ account for later retrieval or viewing.

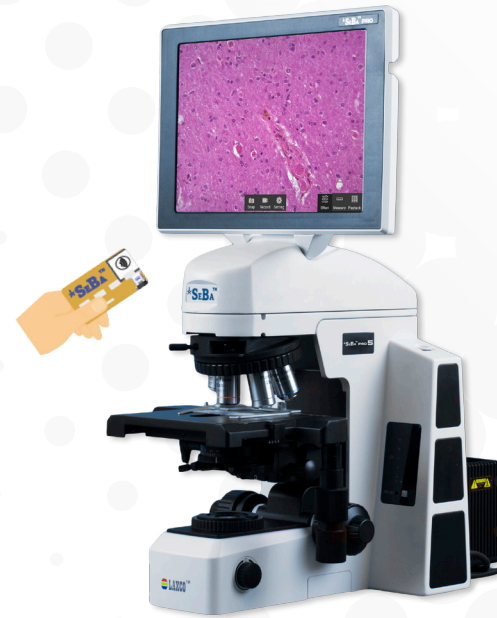

- Capture
- Save
- Annotate

Measure

- Radius
- Angle
- Area
- Line Segment
- Cross Measure
- Cont Line Segment
- Perpendicular
- Point-to-Point

SIMPLE, SEAMLESS INTEGRATION

CAT. NO.	HEAD	OBJECTIVES	OPTICS	FOV	FOCUS CONTROLS	KOEHLER	CONDENSER	ILLUM	STAGE	OBJ TURRET
SEBAP5BF1	SEBA	2X, 4X, 10X, 20X, 40X, 100X Oil	INFINITY, FLUOR	25MM	COARSE & FINE	FULL	0.9 N.A. ABBE, WITH IRIS AND FLIP OUT LENS WITH 0.22 N.A.	5W LED	RACKLESS X/Y MECHANICAL	6 POS
SEBAP5BF1	SEBA	2X, 4X, 10X, 20X, 40X, 100X Oil	INFINITY	25MM	COARSE & FINE	FULL	0.9 N.A. ABBE, WITH IRIS AND FLIP OUT LENS WITH 0.22 N.A.	5W LED	RACKLESS X/Y MECHANICAL	6 POS



LMC-1000 Series FOR EDUCATION



BRIGHTFIELD



Slides



Materials



Dishes



Stage Adjust



Stage drops down to allow for viewing under 2x magnification

- Corrected for eyeglasses
- Flexible Light guide
- LED Illumination
- Rechargeable Battery
- External Power Supply
- 360° Rotating Stage
- Macro & Micro Imaging

FEATURES

- Flexible, easy to adjustable, LED incident light guide for macro applications
- 3 methods of viewing:
 1. Biological (slides)
 2. Macro (solid objects)
 3. Live cell/organism (petri dish)
- Image the same sample under both stereo and compound viewing
- Stereo imaging at 2x and can accommodate samples up to 44mm in height
- 360° rotating stage allows for maximum movement of all sample types
- Fixed condenser simplifies ease of use, making it a perfect solution for students of any age

- Dual high-powered LEDs
- 3 watt, adjustable LED illumination with 50,000 hour life span maintains constant color temperature
- Flexible incident illumination for stereoscopic viewing
- Carrying handle
- Lightweight, stable main body for easy portability
- Brightfield observation
- Finite corrected optical system
- 30° observation angle with interpupillary and diopter adjustments
- Image slides, petri-dishes, and solid materials such as circuit boards, leaves, bark, mushroom, roots, etc...
- Reversed nosepiece allows for easy access to slides
- Adjustable focusing stop protects slide
- External DC Auto-switching power supply (110v - 240v)
- Rechargeable; battery operation for field use provides 8 hours of continuous illumination
- Works for both Macro and Micro viewing
- 360° rotating stage

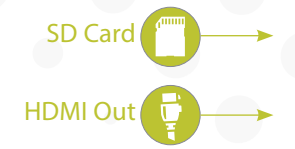

- Save
- Image Capture
- Video Capture
- Video Out to Monitor
- Video Out to Projector



COMBINES BOTH A STEREO & COMPOUND MICROSCOPE INTO ONE

CAT. NO.	HEAD	OBJECTIVES	OPTICS	FOV	F-CONTROLS	KOEHLER	CONDENSER	ILLUM	STAGE	OBJ TURRET
LMC1BF11	MONOC	2X, 4X, 10X, 40X	FIN, DIN, ACHRO	18MM	COARSE & FINE	FIXED	1.25 N.A. ABBE, WITH IRIS	3W LED	360° ROTATING FOR MACRO & MICRO VIEWING	4 POS
LMC1BF12	BINOC	2X, 4X, 10X, 40X	FIN, DIN, ACHRO	18MM	COARSE & FINE	FIXED	1.25 N.A. ABBE, WITH IRIS	3W LED	360° ROTATING FOR MACRO & MICRO VIEWING	4 POS
LMC1BF13	TRINOC	2X, 4X, 10X, 40X	FIN, DIN, ACHRO	18MM	COARSE & FINE	FIXED	1.25 N.A. ABBE, WITH IRIS	3W LED	360° ROTATING FOR MACRO & MICRO VIEWING	4 POS
LMC1BF14	BINOC-DIG	2X, 4X, 10X, 40X	FIN, DIN, ACHRO	18MM	COARSE & FINE	FIXED	1.25 N.A. ABBE, WITH IRIS	3W LED	360° ROTATING FOR MACRO & MICRO VIEWING	4 POS
LMC1BF15	BINOC-DIG-LCD	2X, 4X, 10X, 40X	FIN, DIN, ACHRO	18MM	COARSE & FINE	FIXED	1.25 N.A. ABBE, WITH IRIS	3W LED	360° ROTATING FOR MACRO & MICRO VIEWING	4 POS



LMC-1000 Series FOR EDUCATION



BRIGHTFIELD



- Corrected for eyeglasses
- Carrying Handle
- LED Illumination
- External Power Supply

- Single high-powered LED
- Carrying handle
- Lightweight, stable main body for easy portability
- Brightfield observation
- Finite corrected optical system
- 30° observation angle with interpupillary and diopter adjustments
- 3 watt, adjustable LED illumination with 50,000 hour life span maintains constant color temperature
- Low-position, X/Y axis mechanical stage allows for precise sample movement
- Reversed nosepiece allows for easy access to slides
- Adjustable focusing stop protects slide
- External DC Auto-switching power supply (110v - 240v)
- Rechargeable; battery operation for field use provides 8 hours of continuous illumination

STAND

- Rack and pinion focusing mechanism for smooth focusing control
- Lightweight, portable stand for the classroom environment.
- Stable main body design
- Low-position, rectangular mechanical stage with travel limit and tension adjustment
- Built in carrying handle for easy transportation of microscope
- Coarse and fine focus adjustment
- Reversed quintuple or quadruple nose-piece
- Fixed Koehler illumination with iris diaphragm

USB 2.0 Connectivity



- Recall
- Measure
- Annotate
- Capture
- Save
- Draw
- Print

CAT. NO.	HEAD	OBJECTIVES	OPTICS	FOV	F-CONTROLS	KOEHLER	CONDENSER	ILLUM	STAGE	OBJ TURRET
LMC1BF1	MONOC	4X, 10X, 40X, 100X oil	FIN, DIN, ACHRO	18MM	COARSE & FINE	FIXED	1.25 N.A. ABBE, WITH IRIS	3W LED	X/Y MECH STAGE	4 POS
LMC1BF2	BINOC	4X, 10X, 40X 100X oil	FIN, DIN, ACHRO	18MM	COARSE & FINE	FIXED	1.25 N.A. ABBE, WITH IRIS	3W LED	X/Y MECH STAGE	4 POS
LMC1BF3	TRINOC	4X, 10X, 40X, 100X oil	FIN, DIN, ACHRO	18MM	COARSE & FINE	FIXED	1.25 N.A. ABBE, WITH IRIS	3W LED	X/Y MECH STAGE	4 POS
LMC1BF4	BINOC-DIG	4X, 10X, 40X, 100X oil	FIN, DIN, ACHRO	18MM	COARSE & FINE	FIXED	1.25 N.A. ABBE, WITH IRIS	3W LED	X/Y MECH STAGE	4 POS
LMC1BF5	BINOC-DIG-LCD	4X, 10X, 40X, 100X oil	FIN, DIN, ACHRO	18MM	COARSE & FINE	FIXED	1.25 N.A. ABBE, WITH IRIS	3W LED	X/Y MECH STAGE	4 POS



LMC-2000 Series FOR EDUCATION

- BRIGHTFIELD
- PHASE CONTRAST
- CROSS POLARIZATION
- DARKFIELD TO 40X



- Corrected for eyeglasses
- Carrying Handle
- LED Illumination

- Single high-powered LED
- Carrying handle
- Stable main body
- Brightfield, Darkfield, Simple, Polarization, & Phase Contrast
- Infinity corrected optical system
- 45° observation angle with interpupillary and diopter adjustments
- 3 watt, adjustable LED illumination with 50,000 hour life span maintains constant color temperature
- Low-position, X/Y axis mechanical stage allows for precise sample movement
- Reversed nosepiece allows for easy access to slides
- Adjustable focusing stop protects slide
- Auto-switching power supply (110v - 240v)

STAND

- Rack and pinion focusing mechanism for smooth focusing control
- Stable main body design
- Low-position, rectangular mechanical stage with travel limit and tension adjustment
- Built in carrying handle for easy transportation of microscope
- Coarse and fine focus adjustment
- Reversed quintuple or quadruple nosepiece
- Full Koehler illumination with field and iris diaphragm

USB 2.0 Connectivity



- Recall
- Measure
- Annotate
- Capture
- Save
- Draw
- Print

	CAT. NO.	HEAD	OBJECTIVES	OPTICS	FOV	F-CONTROLS	KOEHLER	CONDENSER	ILLUM	STAGE	OBJ TURRET
BRIGHTFIELD	LMC2BF1	BINOC	4X, 10X, 40X, 100X _{oil}	INFINITY, PL	20MM	COARSE & FINE	FULL	1.25 N.A. ABBE, WITH IRIS, & PH/DF SLOT	3W LED	X/Y MECH STAGE	4 POS
	LMC2BF2	TRINOC	4X, 10X, 40X, 100X _{oil}	INFINITY, PL	20MM	COARSE & FINE	FULL	1.25 N.A. ABBE, WITH IRIS, & PH/DF SLOT	3W LED	X/Y MECH STAGE	4 POS
	LMC2BF4	BINOC-DIG	4X, 10X, 40X, 100X _{oil}	INFINITY, PL	20MM	COARSE & FINE	FULL	1.25 N.A. ABBE, WITH IRIS, & PH/DF SLOT	3W LED	X/Y MECH STAGE	4 POS
DARKFIELD	LMC2DF1	BINOC	4X, 10X, 40X, 100X _{oil}	INFINITY, PL	20MM	COARSE & FINE	FULL	1.25 N.A. ABBE, WITH IRIS, & 4-40 DF SLIDER	3W LED	X/Y MECH STAGE	4 POS
	LMC2DF4	TRINOC	4X, 10X, 40X, 100X _{oil}	INFINITY, PL	20MM	COARSE & FINE	FULL	1.25 N.A. ABBE, WITH IRIS, & 4-40 DF SLIDER	3W LED	X/Y MECH STAGE	4 POS
	LMC2DF5	BINOC-DIG	4X, 10X, 40X, 100X _{oil}	INFINITY, PL	20MM	COARSE & FINE	FULL	1.25 N.A. ABBE, WITH IRIS, & 4-40 DF SLIDER	3W LED	X/Y MECH STAGE	4 POS
CROSS-POL	LMC2-SP1	BINOC	4X, 10X, 40X, 100X _{oil}	INFINITY, PL	20MM	COARSE & FINE	FULL	1.25 N.A. ABBE, WITH IRIS, PH/DF SLOT, CROSS POL KIT	3W LED	X/Y MECH STAGE	4 POS
	LMC2-SP2	TRINOC	4X, 10X, 40X, 100X _{oil}	INFINITY, PL	20MM	COARSE & FINE	FULL	1.25 N.A. ABBE, WITH IRIS, PH/DF SLOT, CROSS POL KIT	3W LED	X/Y MECH STAGE	4 POS
	LMC2-SP3	BINOC-DIG	4X, 10X, 40X, 100X _{oil}	INFINITY, PL	20MM	COARSE & FINE	FULL	1.25 N.A. ABBE, WITH IRIS, PH/DF SLOT, CROSS POL KIT	3W LED	X/Y MECH STAGE	4 POS
PHASE	LMC2PH1	BINOC	10XPH, 20XPH, 40XPH, 100XPH _{oil}	INFINITY, PL PH	20MM	COARSE & FINE	FULL	1.25 N.A. ABBE, WITH IRIS, & 4-100 PH SLIDER	3W LED	X/Y MECH STAGE	4 POS
	LMC2PH2	TRINOC	10X, 20, 40X, 100XPH _{oil}	INFINITY, PL PH	20MM	COARSE & FINE	FULL	1.25 N.A. ABBE, WITH IRIS, & 4-100 PH SLIDER	3W LED	X/Y MECH STAGE	4 POS
	LMC2PH4	BINOC-DIG	10XPH, 20XPH, 40XPH, 100XPH _{oil}	INFINITY, PL PH	20MM	COARSE & FINE	FULL	1.25 N.A. ABBE, WITH IRIS, & 4-100 PH SLIDER	3W LED	X/Y MECH STAGE	4 POS



LMC-3000 Series FOR RESEARCH & CLINICAL

- BRIGHTFIELD
- PHASE CONTRAST
- GOUT ANALYSIS
- DARKFIELD TO 40X
- FLUORESCENCE



- Corrected for eyeglasses
- Carrying Handle
- LED Illumination
- 360° rotating binoc

KEY FEATURES

- Single high-powered LED
- Carrying handle
- Stable main body
- Brightfield, Darkfield, Simple Polarization, Phase Contrast, & Fluorescence Illumination
- High contrast, broad beam optical design

STAND

Large, sturdy based designed for the everyday lab environment.

- Rack and pinion focusing mechanism for smooth focusing control
- Stable main body design
- X/Y mechanical stage
- Built in carrying handle for easy transportation of microscope
- Coarse and fine focus adjustment
- Reversed quintuple or quadruple nose-piece
- Full Koehler illumination with field and iris diaphragm

BINOCULARS & TRINOCULAR OPTICS

- 360° rotating binoculars
- 50 to 75mm interpupillary distance
- Rubber eyecups
- Diopter adjustments

EYEPIECES

- 10x magnification, with 20mm wide field eyepieces
- Optional ability to lock eyepieces

ILLUMINATION

- 3 watt bright white LED
- Removable LED tray
- Adjustable
- Maintains constant color temperature
- 50,000 hour life span

LED FLUORESCENCE

- 25,000 hour life span
- No alignment needed
- LED wave length specific to filter set
- Adjustable light intensity
- High signal to noise ratio
- Stable light excitation energy
- No warm-up or cool down time
- Produces no harmful UV light
- Powered by optional battery pack

- Single Channel Fluorescences
- Hard Coated Filters
- Brightness Control
- Wave-Length Specific LED
- External Power Supply

Rechargeable Battery



	CAT. NO.	HEAD	OBJECTIVES	OPTICS	FOV	F-CONTROLS	KOEHLER	CONDENSER	ILLUM	STAGE	OBJ TURRET	FL FILTERS
BRIGHTFIELD	LMC3BF1	BINOC	4X, 10X, 40X, 100X Oil	INFINITY, PL	22MM	COARSE & FINE	FULL	1.25 N.A. ABBE, WITH IRIS, & PH/DF SLOT	3W LED	X/Y MECH STAGE	5 POS	NA
	LMC3BF4	TRINOC	4X, 10X, 40X, 100X Oil	INFINITY, PL	22MM	COARSE & FINE	FULL	1.25 N.A. ABBE, WITH IRIS, & PH/DF SLOT	3W LED	X/Y MECH STAGE	5 POS	NA
HEMATOLOGY	LMC3HM1	BINOC	4X, 10X, 40X, 50X Oil, 100X Oil	INFINITY, PL	22MM	COARSE & FINE	FULL	1.25 N.A. ABBE, WITH IRIS, & PH/DF SLOT	3W LED	X/Y MECH STAGE	5 POS	NA
	LMC3HM2	TRINOC	4X, 10X, 40X, 50X Oil, 100X Oil	INFINITY, PL	22MM	COARSE & FINE	FULL	1.25 N.A. ABBE, WITH IRIS, & PH/DF SLOT	3W LED	X/Y MECH STAGE	5 POS	NA
GOUT	LMC3GT1	BINOC	4X, 10X, 40X, 50X Oil, 100X Oil	INFINITY, PL	22MM	COARSE & FINE	FULL	1.25 N.A. ABBE, WITH IRIS, PH/DF SLOT, GOUT KIT	3W LED	X/Y MECH STAGE	5 POS	NA
	LMC3GT3	TRINOC	4X, 10X, 40X, 50X Oil, 100X Oil	INFINITY, PL	22MM	COARSE & FINE	FULL	1.25 N.A. ABBE, WITH IRIS, PH/DF SLOT, GOUT KIT	3W LED	X/Y MECH STAGE	5 POS	NA
PHASE	LMC3PH1	BINOC	10XPH, 20XPH, 40XPH, 100XPH Oil	INFINITY, PL PH	22MM	COARSE & FINE	FULL	1.25 N.A. ABBE, WITH IRIS, & 4-100 PH SLIDER	3W LED	X/Y MECH STAGE	5 POS	NA
	LMC3PH5	TRINOC	10XPH, 20XPH, 40XPH, 100XPH Oil	INFINITY, PL PH	22MM	COARSE & FINE	FULL	1.25 N.A. ABBE, WITH IRIS, & 4-100 PH SLIDER	3W LED	X/Y MECH STAGE	5 POS	NA
FLUORESCENCE	LMC3FL43	TRINOC	4X, 10X, 40X, 100X Oil	INFINITY, PL	22MM	COARSE & FINE	FULL	1.25 N.A. ABBE, WITH IRIS, & PH/DF SLOT	3W LED	X/Y MECH STAGE	5 POS	470 +/- 20 525 +/- 20
	LMC3FL44	TRINOC	4X, 10X, 40X, 100X Oil	INFINITY, PL	22MM	COARSE & FINE	FULL	1.25 N.A. ABBE, WITH IRIS, & PH/DF SLOT	3W LED	X/Y MECH STAGE	5 POS	560 +/- 20 645 +/- 37
	LMC3FL45	TRINOC	4X, 10X, 40X, 100X Oil	INFINITY, PL	22MM	COARSE & FINE	FULL	1.25 N.A. ABBE, WITH IRIS, & PH/DF SLOT	3W LED	X/Y MECH STAGE	5 POS	365 +/- 25 420 LP
	LMC3FL46	TRINOC	4X, 10X, 40X, 100X Oil	INFINITY, PL	22MM	COARSE & FINE	FULL	1.25 N.A. ABBE, WITH IRIS, & PH/DF SLOT	3W LED	X/Y MECH STAGE	5 POS	365 +/- 25 460 +/- 25



LMC-4000 Series FOR CLINICAL AND RESEARCH



- Corrected for eyeglasses
- Carrying Handle
- LED Illumination
- Rackless Stage



MULTI-OBSERVATION CONFIGURATIONS

- LED Pointer
- 12V/100W Illumination
- Supports up to 5 heads

KEY FEATURES

- Y-Shaped body for maximum stability
- Carrying handle
- Stable main body
- Brightfield, Darkfield, Polarization, Metallurgical, Phase Contrast, & Fluorescence Contrast Methods
- High contrast, broad beam optical design
- Modular design allows for flexibility in system configuration - 100% customizable for every need

OPTICAL SYSTEM

- Infinity corrected optical system
- Plan Achromat objectives standard, Plan Fluor (optional)
- Wide range of magnifications: 2X, 4x, 10x, 20x, 40x, 60x & 100x
- Anti-reflective coatings on optics
- Sharp images with bright natural color
- Parcentric and parfocal objectives

TRINOCULAR OPTICS

- 10x Eyepieces with 22mm widefield eyepieces
- 50 to 75mm interpupillary distance
- Light splitting ratio 0:100/50:50 (0:100/100:0 on FL models)
- Rubber eyecups
- Diopter adjustment
- Tilting Ergonomic head and standard fixed eyepiece configurations available

STAND

- Large, sturdy base designed for the lab environment
- Rack and pinion focusing mechanism for smooth focus control
- Rackless, X/Y mechanical stage with adjustable tension
- Built-in carrying handle for easy transportation of microscope
- Coarse and fine focus adjustment
- Reversed quintuple nosepiece
- Full Koehler illumination with field and iris diaphragm

	CAT. NO.	HEAD	OBJECTIVES	OPTICS	FOV	F-CONTROLS	KOEHLER	CONDENSER	ILLUM	STAGE	OBJ TURRET
BRIGHTFIELD	LMC4BF1	BINOC	4X, 10X, 40X, 100X Oil	INFINITY, PL	22MM	COARSE & FINE	FULL	1.2 N.A. ABBE, WITH IRIS AND FLIP OUT LENS WITH 0.9 N.A.	5W LED	RACKLESS X/Y MECH STAGE	5 POS
	LMC4BF7	ERGO BINOC	2X, 4X, 10X, 40X, 100X Oil	INFINITY, PL	22MM	COARSE & FINE	FULL	1.2 N.A. ABBE, WITH IRIS AND FLIP OUT LENS WITH 0.9 N.A.	5W LED	RACKLESS X/Y MECH STAGE	5 POS
	LMC4PA1	TILTING ERGO TRINOC	2X, 4X, 10X, 40X, 100X Oil	INFINITY, PL FLUOR	22MM	COARSE & FINE	FULL	1.2 N.A. ABBE, WITH IRIS AND FLIP OUT LENS WITH 0.9 N.A.	5W LED	RACKLESS X/Y MECH STAGE	45POS
	LMC4PA2	TILTING ERGO TRINOC	2X, 4X, 10X, 40X, 100X Oil	INFINITY, PL	22MM	COARSE & FINE	FULL	1.2 N.A. ABBE, WITH IRIS AND FLIP OUT LENS WITH 0.9 N.A.	5W LED	RACKLESS X/Y MECH STAGE	5 POS
	LMC4HM3	TRINOC	4X, 10X, 40X, 50X Oil, 100X Oil	INFINITY, PL	22MM	COARSE & FINE	FULL	1.2 N.A. ABBE, WITH IRIS AND FLIP OUT LENS WITH 0.9 N.A.	5W LED	RACKLESS X/Y MECH STAGE	5 POS
GOUT	LMC4GT4	TRINOC	4X, 10X, 40X, 50X Oil, 100X Oil	INFINITY, PL	22MM	COARSE & FINE	FULL	11.2 N.A. ABBE, WITH IRIS AND FLIP OUT LENS WITH 0.9 N.A. - GOUT KIT	5W LED	RACKLESS X/Y MECH STAGE	5 POS
Darkfield	LMC4DF3	TRINOC	2X, 4X, 10X, 20X, 40X	INFINITY, PL	22MM	COARSE & FINE	FULL	1.25 N.A. ABBE, DARKFIELD Oil UP TO 40X	5W LED	RACKLESS X/Y MECH STAGE	5 POS
	LMC4DF4	TRINOC	4X, 10X, 20X, 40X, 100X Oil	INFINITY, PL	22MM	COARSE & FINE	FULL	1.25 N.A. ABBE, DARKFIELD Oil UP TO 100X	5W LED	RACKLESS X/Y MECH STAGE	5 POS
PHASE	LMC4PH18	TRINOC	4X BF, 10XPH, 20XPH, 40XPH, 100XPH Oil	INFINITY, PL PH	22MM	COARSE & FINE	FULL	1.25 N.A. ABBE, 5-POSITION PHASE CONTRAST TURRET	5W LED	RACKLESS X/Y MECH STAGE	5 POS
PHASE/POL	LMC4-AB3	TRINOC	4X BF, 10XPH, 20XPH, 40XPH	INFINITY, PL PH	22MM	COARSE & FINE	FULL	1.25 N.A. ABBE, 5-POSITION PHASE CONTRAST TURRET	5W LED	RACKLESS X/Y MECH STAGE	5 POS
2 HEAD	LMC4MD2	TRINOC (MAIN) BINOC (OBSERVER)	2X, 4X, 10X, 40X, 100X Oil	INFINITY, PL	22MM	COARSE & FINE	FULL	1.2 N.A. ABBE, WITH IRIS AND FLIP OUT LENS WITH 0.9 N.A.	12V/100W HAL	RACKLESS X/Y MECH STAGE	5 POS
5 HEAD	LMC4MD3	TRINOC (MAIN) BINOC (OBSERVER)	2X, 4X, 10X, 40X, 100X Oil	INFINITY, PL	22MM	COARSE & FINE	FULL	1.2 N.A. ABBE, WITH IRIS AND FLIP OUT LENS WITH 0.9 N.A.	12V/100W HAL	RACKLESS X/Y MECH STAGE	5 POS

LMC-4000 Series

FLUORESCENCE



- Corrected for eyeglasses
- Carrying Handle
- LED Illumination
- Rackless Stage
- Plan Fluor Objectives

KEY FEATURES

- Y-Shaped body for maximum stability
- Carrying handle
- Stable main body
- Brightfield, Darkfield, Polarization, Metallurgical, Phase Contrast, & Fluorescence Contrast Methods
- High contrast, broad beam optical design
- Modular design allows for flexibility in system configuration - 100% customizable for every need

OPTICAL SYSTEM

- Infinity corrected optical system
- Plan Achromat objectives standard, Plan Fluor (optional)
- Wide range of magnifications: 2X, 4x, 10x, 20x, 40x, 60x & 100x
- Anti-reflective coatings on optics
- Sharp images with bright natural color
- Parcentric and parfocal objectives

LED FLUORESCENCE

- 25,000 hour life span
- No alignment needed
- LED wave length specific to filter set
- Adjustable light intensity
- High signal to noise ratio
- Stable light excitation energy
- No warm-up or cool down time
- Produces no harmful UV light
- Powered by optional battery pack

- 4 Channel Fluorescence
- Hard Coated Filters
- Brightness Control
- Wave-Length Specific LED



MERCURY FLUORESCENCE

- Full spectrum illumination
- 100 watt mercury bulb
- Digital power supply
- Centerable lamp housing
- 6 position fluorescence turret
- Brightfield and fluorescence observation
- Fluorescence light block

- Full Spectrum Fluorescence
- Hard Coated Filters
- Mercury Bulb



	CAT. NO.	HEAD	OBJECTIVES	OPTICS	FOV	F-CONTROLS	KOEHLER	CONDENSER	ILLUM	STAGE	OBJ TURRET	GFP FILTER	RFP FILTER	DAPI FILTER
LED FL	LMC4FL4	TRINOC	4X, 10X, 20X, 40X, 100X oil	INFINITY, PL FLUOR	22MM	COARSE & FINE	FULL	1.2 N.A. ABBE, WITH IRIS AND FLIP OUT LENS WITH 0.9 N.A.	5W LED	RACKLESS X/Y MECH STAGE	5 POS	470 +/- 20 525 +/- 20	560 +/- 20 645 +/- 37	365 +/- 25 460 +/- 25
MERCURY FL	LMC4FL2	TRINOC	4X, 10X, 20X, 40X, 100X oil	INFINITY, PL FLUOR	22MM	COARSE & FINE	FULL	1.2 N.A. ABBE, WITH IRIS AND FLIP OUT LENS WITH 0.9 N.A.	5W LED	RACKLESS X/Y MECH STAGE	5 POS	470 +/- 20 525 +/- 20	560 +/- 20 645 +/- 37	365 +/- 25 460 +/- 25

LMC-4000 Series POLARIZATION

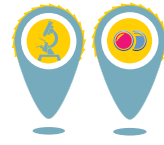

POLARIZATION



- Corrected for eyeglasses
- Carrying Handle
- LED Transmitted Illumination
- Stage Locking
- Stress Free Objectives
- 50W Halogen

KEY FEATURES

- Y-Shaped body for maximum stability
- Carrying handle
- Can be purchased pre-configured or customized for your specific requirements
- High contrast, broad beam optical design
- Modular Transmitted and reflected light polarization for identification of crystallized structures in biological or material samples
- Can be purchased pre-configured or customized for your specific requirements
- Anti-corrosive and friction coated, graphite stage
- Intermediate device for conoscopic observation with internal Bertrand lens, Analyzer, Compensator, and Wave Plates. Easily determine the degree of polarization for crystal identification.

OPTICAL SYSTEM

- Infinity corrected optical system
- Plan POL and LMPlan POL objectives available
- Wide range of magnifications: 4x, 5x, 10x, 20x, 40x, 60x & 100x
- Central stop dispersion staining objectives available for asbestos analysis
- Sharp images with bright natural color
- Parcentric and parfocal objectives

STAND

- Large, sturdy base designed for the lab environment
- Rack and pinion focusing mechanism for smooth focus control
- Rotating Stage with Stage Lock
- Coarse and fine focus adjustment
- Centerable objective nosepiece
- Full Koehler illumination with field and iris diaphragm

- Eyepiece Rotation Lock
- Centerable Objective Turret
- 50W Halogen
- 360° Rotating Stage
- Locking Stage



Bayonet locking mechanism on eyepiece ensures that the reticle remains orthogonal with the polarizer and analyzer.



50 Watt reflected light illuminator allows for viewing transmitted or reflected light. A pre-centered bulb ensure easy replacement of the bulb.



Intermediate device for conoscopic observation with internal Bertrand lens, Analyzer, Compensator, and Wave Plates. Easily determine the degree of polarization for crystal identification.

CAT. NO.	HEAD	OBJECTIVES	OPTICS	FOV	F-CONTROLS	KOEHLER	CONDENSER	ILLUM	STAGE	OBJ TURRET
LMC4PL5	TRINOC	4X, 10X, 20X, 60X	INFINITY, STRAIN FREE PL	22MM	COARSE & FINE	FULL	1.2 N.A. ABBE, WITH IRIS AND FLIP OUT LENS WITH 0.9 N.A.	TRANSMITTED 50W HAL	ROUND, ROTATING	4 POS CENTERABLE
LMC4PL6	TRINOC	5X, 10X, 20X, 50X	INFINITY, STRAIN FREE LMPL	22MM	COARSE & FINE	FULL	1.2 N.A. ABBE, WITH IRIS AND FLIP OUT LENS WITH 0.9 N.A.	TRANSMITTED AND REFLECTED 50W HAL	ROUND, ROTATING	4 POS, CENTERABLE
LMC4-AB2	TRINOC	4X, 10X (CS), 20X, 40X (CS)	INFINITY STRAIN FREE, CENTRAL STOP (10X & 40X)	22MM	COARSE & FINE	FULL	1.2 N.A. ABBE, WITH IRIS AND FLIP OUT LENS WITH 0.9 N.A.	TRANSMITTED 50W HAL	ROUND, ROTATING	4 POS CENTERABLE

LMC-4000 Series METALLURGICAL



- Corrected for eyeglasses
- Carrying Handle
- LED Illumination
- Stage Locking
- LMPLAN Objectives
- Adjustable Stage

STAND

- Large, sturdy base designed for the lab environment
- Rack and pinion focusing mechanism for smooth focus control
- Adjustable stage height. 28mm sample height in transmitted and 78mm high samples in reflected light allows for maximum flexibility on the times of materials that can be viewed on this system
- Coarse and fine focus adjustment
- Full Koehler illumination with field and iris diaphragm

- Centerable Objective Turret
- 50W Halogen
- Rotating Stage
- Locking Stage



5 Watt reflected light illuminator with field and iris diaphragm, polarization and color filter options.



Both transmitted and reflected light options with independent light intensity control.

KEY FEATURES

- Y-Shaped body for maximum stability
- Carrying handle
- Ultra-Bright LED Illumination, reflected and transmitted light for Material Science applications
- Reflected and transmitted light for Material Science applications
- Can be purchased separately or in a pre-configured system

OPTICAL SYSTEM

- Infinity corrected optical system
- LMPlan objectives
- Wide range of magnifications: 5x, 10x, 20x, 50x & 100x
- Sharp images with bright natural color
- Parcentric and parfocal objectives

OBJECTIVES

Series	Magnification	N.A.	W.D.	F.N.	Cover glass thickness	Immersion
LMPlan	5x	0.15	10.80	22	-	/
	10x	0.30	10.00	22	-	/
	20x	0.45	4.00	22	-	/
	50x	0.55	7.90	22	-	/
	100x	0.80	2.10	22	-	/



CAT. NO.	HEAD	OBJECTIVES	OPTICS	FOV	F-CONTROLS	KOEHLER	CONDENSER	ILLUM	STAGE	OBJ TURRET
LMC4PL5	TRINOC	4X, 10X, 20X, 60X	INFINITY, STRAIN FREE PL	22MM	COARSE & FINE	FULL	1.2 N.A. ABBE, WITH IRIS AND FLIP OUT LENS WITH 0.9 N.A.	TRANSMITTED 50W HAL	ROUND, ROTATING	4 POS CENTERABLE
LMC4PL6	TRINOC	5X, 10X, 20X, 50X	INFINITY, STRAIN FREE LMPL	22MM	COARSE & FINE	FULL	1.2 N.A. ABBE, WITH IRIS AND FLIP OUT LENS WITH 0.9 N.A.	TRANSMITTED AND REFLECTED 50W HAL	ROUND, ROTATING	4 POS, CENTERABLE
LMC4-AB2	TRINOC	4X, 10X (CS), 20X, 40X (CS)	INFINITY STRAIN FREE, CENTRAL STOP (10X & 40X)	22MM	COARSE & FINE	FULL	1.2 N.A. ABBE, WITH IRIS AND FLIP OUT LENS WITH 0.9 N.A.	TRANSMITTED 50W HAL	ROUND, ROTATING	4 POS CENTERABLE

LMC-5000 Series RESEARCH

After years of research and development in optical technology, Laxco has developed its flagship series; the LMC-5000. The LMC-5000 series brings the highest level of performance to Laxco's LMC product line and brings features and functionality that researchers require. Superior image quality, advanced contrast methods, high precision stage, large field of view, and advanced controls makes the LMC-5000 series a leader in its class.

KEY FEATURES

- Large T-Shaped body for maximum stability
- Carrying handle
- Stable main body
- Brightfield, Metallurgical, & Fluorescence Contrast Methods
- High contrast, broad beam optical design
- Modular design allows for flexibility in system configuration - 100% customizable for every need



OPTICAL SYSTEM

- Infinity corrected optical system
- Plan fluor objectives
- Wide range of magnifications: 2x, 4x, 10x, 20x, 40x, 60x, 50X Oil & 100x
- Anti-reflective coatings on optics
- Sharp images with color corrected optics
- Parcentric & Parfocal objectives



STAND

- Modular frame design
- Integrated LBD and ND filters
- Stable main body design
- Rackless, wire driven X/Y mechanical stage
- Coaxial focus drive, with focus range of 25mm and 1 um precision
- Reversed 6-position nosepiece (7-position optional)
- 12V/100W halogen transmitted illumination
- Full Koehler illumination with field and iris diaphragm

MULTI-OBSERVATION CONFIGURATIONS

- LED Pointer
- 12V/100W Illumination
- Supports up to 5 heads



	CAT. NO.	HEAD	OBJECTIVES	OPTICS	FOV	F-CONTROLS	KOEHLER	CONDENSER	ILLUM	STAGE	OBJ TURRET
BRIGHTFIELD	LMC5BF1	TRINOC	4X, 10X, 20X, 40X, 100x Oil	INFINITY, PLAN FLUOR	25MM	COARSE & FINE	FULL	ABBE, WITH IRIS AND FLIP OUT LENS WITH 0.9 N.A.	TRANSMITTED 12V/100W HAL	RACKLESS X/Y MECH STAGE	6 POS
	LMC5BF2	TILTING TRINOC	4X, 10X, 20X, 40X, 100x Oil PLAN FLUOR 50X Oil PLAN	INFINITY, PLAN FLUOR, 50x PLAN	25MM	COARSE & FINE	FULL	ABBE, WITH IRIS AND FLIP OUT LENS WITH 0.9 N.A.	TRANSMITTED 12V/100W HAL	RACKLESS X/Y MECH STAGE	6 POS
	LMC5HM1	TRINOC	4X, 10X, 20X, 40X, 100x Oil PLAN FLUOR 50X Oil PLAN	INFINITY, PLAN FLUOR, 50x PLAN	25MM	COARSE & FINE	FULL	ABBE, WITH IRIS AND FLIP OUT LENS WITH 0.9 N.A.	TRANSMITTED 12V/100W HAL	RACKLESS X/Y MECH STAGE	6 POS
5 HEAD	LMC5MD1	TRINOC (MAIN) BINOC (OBSERVER)	4X, 10X, 20X, 40X, 100x Oil	INFINITY, PLAN FLUOR	22MM	COARSE & FINE	FULL	ABBE, WITH IRIS AND FLIP OUT LENS WITH 0.9 N.A.	TRANSMITTED 12V/100W HAL	RACKLESS X/Y MECH STAGE	6 POS
2 HEAD	LMC5MD3	TRINOC (MAIN) BINOC (OBSERVER)	4X, 10X, 20X, 40X, 100x Oil	INFINITY, PLAN FLUOR	22MM	COARSE & FINE	FULL	ABBE, WITH IRIS AND FLIP OUT LENS WITH 0.9 N.A.	TRANSMITTED 12V/100W HAL	RACKLESS X/Y MECH STAGE	6 POS

LMC-5000 Series **FLUORESCENCE**



CUSTOM FILTER OPTIONS

HARD COATED FILTERS

The LMC-5000 fluorescence models utilize hard coating technology to provide superior performance and durability. Unlike more traditional soft coated filters which only block out 60% of the unwanted light and break down over time under UV light, resulting in lower blocking efficiencies; hard coated filters block out 90% of the unwanted light, and do not break down over time under any wave-length of light. This greater efficiency produces superior signal to noise ratio.

Fluorescence Filter

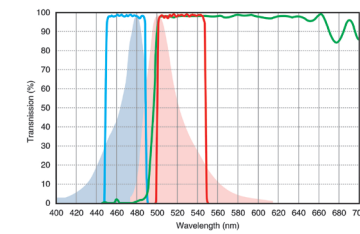

KEY FEATURES

- Blocks out 90% of unwanted light
- Coatings do not break down over time
- Superior signal to noise ratio

MERCURY FLUORESCENCE

- Full spectrum illumination
- 100 watt mercury bulb
- Digital power supply
- Centerable lamp housing
- 6 position filter turret
- Brightfield and fluorescence observation
- Fluorescence light block



OBJECTIVES

Series	Magnification	N.A.	W.D.	F.N.	Cover glass thickness	Immersion	Spring
Plan Fluor Series	4x	0.13	18.5	25	0.17	/	/
	10x	0.30	10.6	25	0.17	/	/
	20x	0.50	2.33	25	0.17	/	/
	40x	0.75	0.6	25	0.17	/	/
	100x	1.28	0.21	25	0.17	oil	/

CAT. NO.	HEAD	OBJECTIVES	OPTICS	FOV	F-CONTROLS	KOEHLER	CONDENSER	ILLUM	STAGE	OBJ TURRET
LMC5FL1	TRINOC	4X, 10X, 20X, 40X, 100X Oil	INFINITY, PLAN FLUOR	25MM	COARSE & FINE	FULL	ABBE, WITH IRIS AND FLIP OUT LENS WITH 0.9 N.A.	TRANSMITTED 12V/100W HAL	RACKLESS X/Y MECH STAGE	6 POS

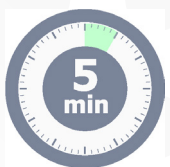

5 MINUTE WARM UP TIME



CENTERABLE FIELD DIAPHRAGM

LMC-5000 Series METALLURGICAL

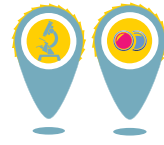

REFLECTED ILLUMINATOR

- Brightfield and Darkfield Illumination
- BF/DF Plan Fluor metallurgical objectives
- Polarization filters



OPTICAL SYSTEM

- Infinity corrected optical system
- BF/DF Plan Fluor metallurgical objectives
- 25MM FOV
- Wide range of magnifications: 5x, 10x, 20x, 50x, 100x
- Anti-reflective coatings on optics
- Sharp images with color corrected optics
- Parcentric & Parfocal objectives



KEY FEATURES

- Reflected and reflected/transmitted light configurations for Material Science applications
- Can be purchased separately or in a pre-configured system
- 12V/100W Halogen Illumination
- Large T-Shaped body for maximum stability
- High contrast, broad beam optical design
- Modular design allows for flexibility in system configuration - 100% customizable for every need

	CAT. NO.	HEAD	OBJECTIVES	OPTICS	FOV	F-CONTROLS	KOEHLER	CONDENSER	ILLUM	STAGE	OBJ TURRET
TRANSMITTED	LMC5MT1	TRINOC	5X, 10X, 20X, 40X, 100X	INFINITY, MPLANFL BF/DF	25MM	COARSE & FINE	FULL	ABBE, WITH IRIS AND FLIP OUT LENS WITH 0.9 N.A.	TRANSMITTED 12V/100W HAL	DOUBLE LAYER MECH STAGE	6 POS
TRANSMITTED REFLECTED	LMC5MT2	TRINOC	5X, 10X, 20X, 40X, 100X	INFINITY, MPLANFL BF/DF	25MM	COARSE & FINE	FULL	ABBE, WITH IRIS AND FLIP OUT LENS WITH 0.9 N.A.	TRANSMITTED/ REFLECTED 12V/100W HAL	DOUBLE LAYER MECH STAGE	6 POS

LMI-6000 Series **INVERTED**

Ideal for observing critical live cultures, large specimens, and reactions. The ergonomic, robust design efficiently accommodates specimens within all types of culture vessels and multi-well plates. Laxco's LMI-6000 inverted microscopes are the practical choice for research, education, and routine lab use.

KEY FEATURES

- Large T-Shaped body for maximum stability
- ECO IR sensor automatically saves power when scope is not in use
- 5W transmitted LED
- Brightfield, Phase Contrast and Fluorescence Contrast Methods
- High contrast for cell and tissue culture applications
- Optional mechanical stage for precise x/y control of samples.

Corrected for eyeglasses

Infinity Corrected

LED Illumination

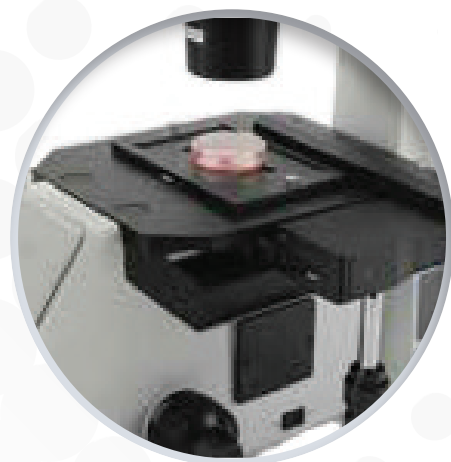

OPTICAL SYSTEM

- Infinity corrected optical system
- Plan Achromatic and Plan Fluor LWD objectives
- Wide range of magnifications: 4x, 10x, 20x, 40x, 60x & 100x
- Anti-reflective coatings on optics
- Sharp images with color corrected optics
- Parcentric & Parfocal objectives

Still Camera Or Video Camera



TRINOCULAR OBSERVATION HEAD

- Integrated trinocular photo port
- 10x magnification, with 22mm wide field eyepieces w/eyecups
- 50 to 75mm interpupillary distance
- 50:50 image split
- 45° inclined head, 360° rotating

STAND

- Sturdy base designed for the research lab environment
- Attachable X/Y mechanical stage
- Coaxial focus drive, 2 um precision
- Quadruple nosepiece
- 5w LED transmitted illumination
- N.A. 0.3 condenser, working distance 72mm, removable
- Phase contrast slider
- ECO IR Sensor

CAT. NO.	HEAD	OBJECTIVES	OPTICS	FOV	F-CONTROLS	KOEHLER	CONDENSER	ILLUM	STAGE	OBJ TURRET
LMI6PH1	TRINOC	4X, 20X LWD PLAN PH	INFINITY, LWD PLAN PH	22MM	COARSE & FINE	FULL	N.A 0.3 CONDENSER, 72MM WD	5W LED	FIXED	4 POS
LMI6PH2	TRINOC	4X, 10X, 20X, 40X LWD PLAN PH	INFINITY, LWD PLAN PH	22MM	COARSE & FINE	FULL	N.A 0.3 CONDENSER, 72MM WD	5W LED	X/Y MECH STAGE	4 POS
LMI6PH23	TRINOC	4X, 20X LWD PLAN FLUOR PH	INFINITY, LWD PLAN FLUOR PH	22MM	COARSE & FINE	FULL	N.A 0.3 CONDENSER, 72MM WD	5W LED	FIXED	4 POS
LMI6PH24	TRINOC	4X, 10X, 20X, 40X LWD PLAN FLUOR PH	INFINITY, LWD PLAN FLUOR PH	22MM	COARSE & FINE	FULL	N.A 0.3 CONDENSER, 72MM WD	5W LED	X/Y MECH STAGE	4 POS

MS Series **FIXED MAGNIFICATION**



Laxco stereo microscopes are among the most common instruments found for general laboratory use. The MS Series utilizes a fixed magnification optical system, which makes switching between magnification quick and easy. Its all metal construction gives the stand its ruggedness, while its precision optics, deliver crisp clear images. Independently controlled, transmitted fluorescent and reflected halogen illumination shines homogenized light from above and below the sample, and the oversized dual focus knobs allows for both left and right hand operation.

KEY FEATURES

- Choose between multiple combinations of magnifications*
- Dual diopter adjustments accommodates different eye focal length
- Parfocality maintained between magnification
- Clearly marked knurled knobs for magnification

* Changing eyepiece to 15x or 20x is required



BINOCULAR OPTICS

Two clearly knurled knobs on either side of the optical head allow the user to easily switch between a pair of fixed magnifications. Multiple combinations of magnification available to include 10/20x, 10/30x, 20/40x, 15/30x, 15/45x, 30/60x, 10/60x, and 40/80x.

Dual, side-mounted knobs clearly mark the magnification value and allow the user to quickly identify their magnification. Highly polished lenses create a smooth flat field of view with crisp, shape resolution. Parfocality is maintained when switching between high and low magnifications to prevent constant searching and refocusing of sample.

STAND

Small foot print and rugged design allows this stand to be used anywhere. Oversized dual focus knobs, with slip clutch prevents damage to gearing due to accidental overturning, and easily switch between left and right hand operation.

- Rugged, all metal construction
- Large, contoured stage
- Left and right hand operation
- Slip clutch prevents damage to the focusing mechanism

ILLUMINATION

Built-in, independently controlled, transmitted fluorescent and reflected halogen illumination shines homogenized light from above and below onto the sample. Each light source intensity and operation can be individual controlled, giving the user maximum flexibility. Upper Halogen light angle can be adjusted to allow illumination to illuminate a particular area of the sample.

- 5w fluorescent lower illumination
- 15 watt halogen, with reflector for upper illumination
- Individually control light sources

SPECIFICATIONS



Part Number	MS-102
Head Type	Binocular
Zoom Range	10x and 20x
Field of View (FOV)	20mm and 10mm
Working Distance (WD)	110mm



Part Number	MS-103
Head Type	Binocular
Zoom Range	10x and 30x
Field of View (FOV)	20mm and 6.6mm
Working Distance (WD)	110mm



Part Number	MS-204
Head Type	Binocular
Zoom Range	20x and 40x
Field of View (FOV)	10mm and 5mm
Working Distance (WD)	110mm

CAT. NO.	HEAD	OBJECTIVES	MAGNIFICATION	FIXED/ZOOM	EYEPIECES	ILLUMINATION	OBJ. TURRET
MS102	BINOC	1x, 2x	10x, 20x	FIXED	10x	REFLECTED: 15W HAL TRANSMITTED: 5W FLUORESCENT	2 POS
MS10215	BINOC	1x, 2x	15x, 30x	FIXED	15x	REFLECTED: 15W HAL TRANSMITTED: 5W FLUORESCENT	2 POS
MS103	BINOC	1x, 3x	10x, 30x	FIXED	10x	REFLECTED: 15W HAL TRANSMITTED: 5W FLUORESCENT	2 POS
MS204	BINOC	2x, 4x	20x, 40x	FIXED	10x	REFLECTED: 15W HAL TRANSMITTED: 5W FLUORESCENT	2 POS
MS20415	BINOC	2x, 4x	30x, 60x	FIXED	15x	REFLECTED: 15W HAL TRANSMITTED: 5W FLUORESCENT	2 POS
MS20420	BINOC	2x, 4x	40x, 80x	FIXED	20x	REFLECTED: 15W HAL TRANSMITTED: 5W FLUORESCENT	2 POS

MZS1 Series COMPACT ILLUMINATION BASE



Laxco stereo microscopes are among the most common instruments found for general laboratory use. The MZS1 Series combines a traditional design with a modern touch. Its all metal construction gives the stand its ruggedness, while its precision optics, deliver crisp clear images throughout a continuous zoom range. Independently controlled, transmitted fluorescent and reflected halogen illumination shines homogenized light from above and below the sample, and the oversized dual focus knobs allows for both left and

DIGITAL HEAD

Digital head with built in 3MP camera and USB output. Easily connect the digital camera directly to a PC for live image viewing and capturing with included Micron software.

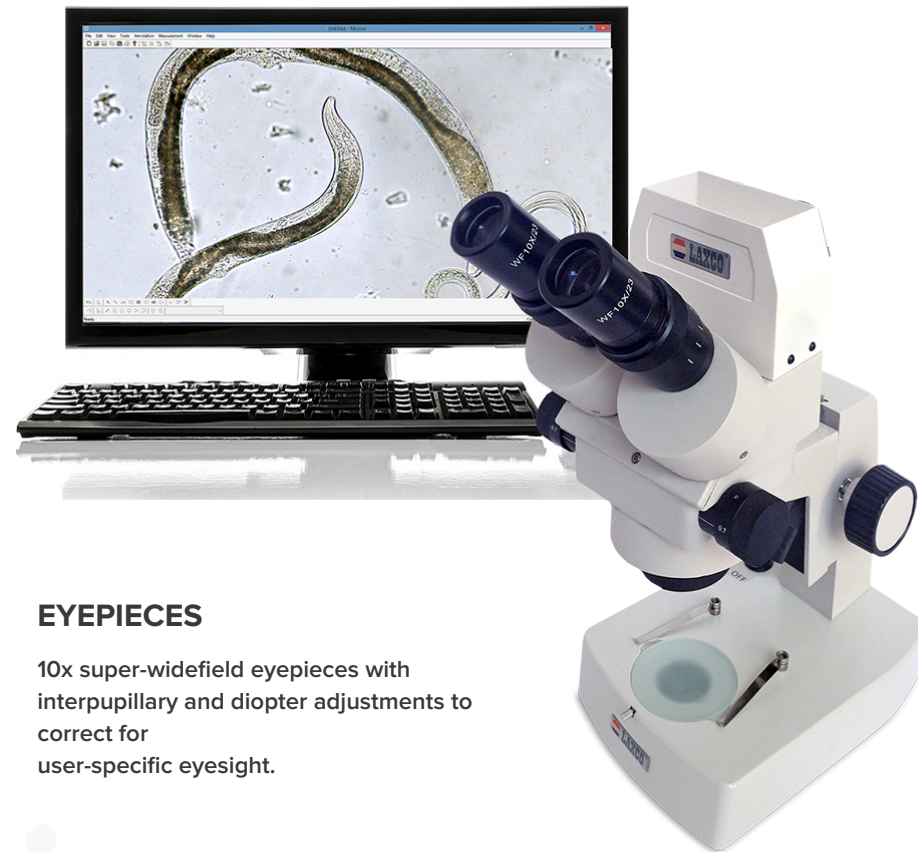

STANDARD ZOOM OPTICS

Primary magnification range of 0.7x to 4.5X magnification range (7x to 45x when used with a 10x eyepiece), with expandability to 180x. Its parfocal zoom control delivers crisp, clear images throughout the entire zoom magnification range. Dual, side-mounted knobs clearly mark the magnification value, and allows the user to quickly identify their magnification.

EYEPIECES

10x super-widefield eyepieces with interpupillary and diopter adjustments to correct for user-specific eyesight.

ILLUMINATION

Built-in, independently controlled, transmitted fluorescent and reflected halogen illumination shines homogenized light from above and below onto the sample. Each light source intensity and operation can be individual controlled, giving the user maximum flexibility. Upper Halogen light angle can be adjusted to allow illumination to illuminate a particular area of the sample.

- 5 watt fluorescent lower illumination
- 15 watt halogen, with reflector for upper illumination
- Individually control light sources

STAND

Traditional design and rugged stand is built to last a life-time. Its wide base, and oversized dual focus knobs for left and right hand operation allow for easy operation.

- Rugged, all metal construction
- Large, contoured stage
- Left and right hand operation

SPECIFICATIONS



Part Number	MZS1-MZD3
Head Type	Binoc + Digital 3MP Camera
Zoom Range	7x – 45x
Resolution	25µm – 3.8µm
Field of View (FOV)	32.8mm – 5.1mm
Working Distance (WD)	93mm
Zoom Ratio	6.4:1
Software	Micron



Part Number	MZS1-MZ22
Head Type	Binocular
Zoom Range	7x – 45x
Resolution	25µm – 3.8µm
Field of View (FOV)	32.8mm – 5.1mm
Working Distance (WD)	93mm
Zoom Ratio	6.4:1
Software	None



Part Number	MZS1-MZ23
Head Type	Trinocular
Zoom Range	7x – 45x
Resolution	25µm – 3.8µm
Field of View (FOV)	32.8mm – 5.1mm
Working Distance (WD)	93mm
Zoom Ratio	6.4:1
Software	None

CAT. NO.	HEAD	OBJECTIVES	AUX. LENS	OPTICAL MAGNIFICATION	FIXED/ZOOM	EYEPIECES	ILLUMINATION
MZS222	BINOC	0.7x-4.5x	NA	7X-45X	ZOOM	10x	REFLECTED: 15W HAL TRANSMITTED: 5W FLUORESCENT
MZS223	TRINOC	0.7x-4.5x	NA	7x-45x	ZOOM	10X	REFLECTED: 15W HAL TRANSMITTED: 5W FLUORESCENT
MZS2221	BINOC	0.7x-4.5x	2x	14x-90x	ZOOM	15Wx	REFLECTED: 15W HAL TRANSMITTED: 5W FLUORESCENT
MZS1222	BINOC	0.7x-4.5x	2X	28x-180x	ZOOM	20X	REFLECTED: 15W HAL TRANSMITTED: 5W FLUORESCENT
MZS1D3	BINOC + DIGITAL	0.7x-4.5x	NA	7X-45X	ZOOM	10x	REFLECTED: 15W HAL TRANSMITTED: 5W FLUORESCENT



MZS2 Series POLE ILLUMINATION BASE

The MZS2 Series combines a traditional design with a pole stand. Its all metal construction gives the stand the ruggedness, while its precision optics, deliver crisp clear images throughout a continuous zoom range. Independently controlled, transmitted fluorescent and reflected halogen illumination shines homogenized light from above and below the sample, and the oversized dual focus knobs allows for both left and right hand operation.

DIGITAL HEAD

Digital head with built in 3MP camera and USB output. Easily connect the digital camera directly to a PC for live image viewing and capturing with included Micron software.



STANDARD ZOOM OPTICS

Primary magnification range of 0.7x to 4.5X magnification range (7x to 45x when used with a 10x eyepiece), with expandability to 180x. Its parfocal zoom control delivers crisp, clear images throughout the entire zoom magnification range. Dual, side-mounted knobs clearly mark the magnification value, and allows the user to quickly identify their magnification.

STAND

Traditional design, and rugged stand is built to last a lifetime. 12" vertical pole allows adjustments for both large and small samples, and easily rotates to the side to macro samples that do not fit on its stage. Its wide base, and oversized dual focus knobs for left and right hand operation allow for easy operation.

- Rugged, all metal construction
- Large, contoured stage
- Left and right hand operation
- Slip clutch prevents damage to the focusing mechanism

EYEPIECES

10x super-widefield eyepieces with interpupillary and diopter adjustments to correct for user-specific eyesight.

ILLUMINATION

Built-in, independently controlled, transmitted fluorescent and reflected halogen illumination shines homogenized light from above and below onto the sample. Each light source intensity and operation can be individual controlled, giving the user maximum flexibility. Upper Halogen light angle can be adjusted to allow illumination to illuminate a particular area of the sample.

- 5 watt fluorescent lower illumination
- 15 watt halogen, with reflector for upper illumination
- Individually control light sources

SPECIFICATIONS



Part Number	MZS1-MZD3
Head Type	Binoc + Digital 3MP Camera
Zoom Range	7x – 45x
Resolution	25µm – 3.8µm
Field of View (FOV)	32.8mm – 5.1mm
Working Distance (WD)	93mm
Zoom Ratio	6.4:1
Software	Micron



Part Number	MZS2-MZ22
Head Type	Binocular
Zoom Range	7x – 45x
Resolution	25µm – 3.8µm
Field of View (FOV)	32.8mm – 5.1mm
Working Distance (WD)	93mm
Zoom Ratio	6.4:1
Software	None



Part Number	MZS2-MZ23
Head Type	Trinocular
Zoom Range	7x – 45x
Resolution	25µm – 3.8µm
Field of View (FOV)	32.8mm – 5.1mm
Working Distance (WD)	93mm
Zoom Ratio	6.4:1
Software	None

CAT. NO.	HEAD	OBJECTIVES	AUX. LENS	OPTICAL MAGNIFICATION	FIXED/ZOOM	EYEPIECES	ILLUMINATION
MZS122	BINOC	0.7x-4.5x	NA	7X-45X	ZOOM	10x	REFLECTED: 15W HAL TRANSMITTED: 5W FLUORESCENT
MZS123	TRINOC	0.7x-4.5x	NA	7x-45x	ZOOM	10X	REFLECTED: 15W HAL TRANSMITTED: 5W FLUORESCENT
MZS1231	TRINOC	0.7x-4.5x	2x	14x-90x	ZOOM	15Wx	REFLECTED: 15W HAL TRANSMITTED: 5W FLUORESCENT
MZS1232	TRINOC	0.7x-4.5x	2X	28x-180x	ZOOM	20X	REFLECTED: 15W HAL TRANSMITTED: 5W FLUORESCENT
MZS1D3	BINOC + DIGITAL	0.7x-4.5x	NA	7X-45X	ZOOM	10x	REFLECTED: 15W HAL TRANSMITTED: 5W FLUORESCENT
MZS1D31	BINOC + DIGITAL	0.7x-4.5x	2X	14x-90x	ZOOM	15x	REFLECTED: 15W HAL TRANSMITTED: 5W FLUORESCENT
MZS1D32	BINOC + DIGITAL	0.7x-4.5x	2X	28x-180x	ZOOM	20x	REFLECTED: 15W HAL TRANSMITTED: 5W FLUORESCENT

D10 Series

STANDARD ILLUMINATION BASE



Laxco stereo zoom microscopes are among the most common instruments found for general laboratory use. They combine excellent stereoscopic zoom capabilities, with small-footprint stands, and built-in illumination from above and below the sample. These traditional optical stereo microscopes are research-grade, with top level performance, and a wide choice of zoom magnification ranges.

The D10 series traditional design and rugged stand is built to last a lifetime. Its high resolution optics and wide range of magnifications, deliver crisp clear images of the sample. Independently controlled, dual halogen illumination shines homogenized light from above and below the sample. Wide base and oversized dual focus knobs for left and right hand operation allow for easy operation. Contoured stage, provides ergonomics and comfort during delicate procedures.



BROAD-RANGE ZOOM OPTICS

Broad-Range magnification head with 0.65x to 6x primary magnification range (6.5x to 60x when used with a 10x eyepiece). Its parfocal zoom control delivers crisp, clear images throughout the zoom magnification range.

Dual, side-mounted knobs clearly mark the magnification value, and allows the user to quickly identify their magnification.

Optional supplementary lenses and eyepiece alternatives are available to increase or decrease magnification range.

STAND

Traditional design, and rugged stand is built to last a life-time. Its wide base and oversized dual focus knobs for left and right hand operation allow for easy operation. Contoured stage provides ergonomics and comfort during delicate procedures.

- Rugged, all metal construction
- Large, contoured stage

ILLUMINATION

Built-in, independently controlled, dual halogen illumination shines homogenized light from above and below onto the sample. Each light source intensity and operation can be individual controlled, giving the user maximum flexibility. Upper Halogen light angle can be adjusted to allow illumination to illuminate a particular area of the sample.

- 20 watt halogen lower illumination
- 15 watt halogen, with reflector for upper illumination
- Individually control light sources

KEY FEATURES

- Binocular and trinocular (for camera) options
- Dual diopter adjustments
- Broad range in magnification from 6.5x to 60x (optional range 3.5x to 120x)
- Smooth, continuous parfocal zoom
- 9.2:1 zoom ratio
- 23mm photo port (trinocular model only)
- Switch easily between camera and eyepieces (trinocular model only)

DIGITAL HEAD

Digital head with built in 3MP camera and USB output. Easily connect the digital camera directly to a PC for live image viewing and capturing with included Micron software.



Part Number	D10-MV2
Head Type	High-resolution (3MP)
Zoom Range	11x – 88x (27" monitor)
Resolution	100µm – 7.7µm
Field of View (FOV)	27mm – 3.35mm
Working Distance (WD)	85 mm
Zoom Ratio	32:1
Software	Micron USB 2.0



Part Number	D10-Z32
Head Type	Binocular
Zoom Range	6.5x – 60x
Resolution	25µm – 4µm
Field of View (FOV)	35.38 – 3.83mm
Working Distance (WD)	110mm
Zoom Ratio	9:2:1
Software	None



Part Number	D10-Z33
Head Type	Trinocular
Zoom Range	6.5x – 60x
Resolution	25µm – 4µm
Field of View (FOV)	35.38 – 3.83mm
Working Distance (WD)	110mm
Zoom Ratio	9:2:1
Software	None

CAT. NO.	HEAD	OBJECTIVES	FOV	MAGNIFICATION	FIXED/ZOOM	EYEPIECES	ILLUMINATION
D10MV2	DIGITAL (3MP)	1.1 - 8.8X	27MM - 7.7MM	11X - 88X (27" monitor)	ZOOM	NA	REFLECTED: HALOGEN TRANSMITTED: HALOGEN
D10Z32	BINOC	0.65X - 6.0X	35.38MM - 3.83MM	6.5X - 60X	ZOOM	10X	REFLECTED: HALOGEN TRANSMITTED: HALOGEN
D10Z33	TRINOC	0.65X - 6.0X	35.38MM - 3.83MM	6.5X - 60X	ZOOM	10x	REFLECTED: HALOGEN TRANSMITTED: HALOGEN



T40 Series LED ILLUMINATION BASE

The T40 Series large, low profile platform makes every day work, simple and easy. Its integrated cluster of 24 LED's (720cd total) provide super bright white cooled illumination, which is comparable to a traditional 150 watt fiber optic illumination. The systems flexible upper light guides and lower LED transmitted illumination gives the user an unprecedented amount of control and versatility in how the sample is illuminated. With its continuous vertical gear track, this system can accommodate samples of all shapes and sizes easily and comfortably.

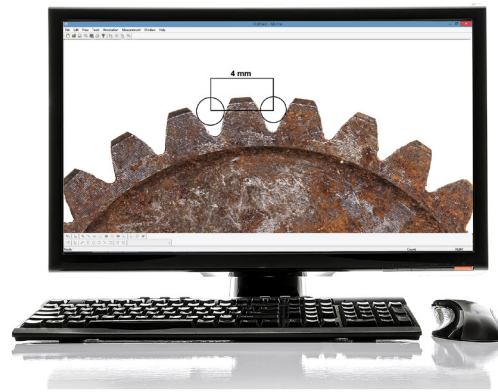

KEY FEATURES

- Binocular and trinocular (for camera) options
- Dual diopter adjustments accommodates different eye focal length
- Broad range in magnification from 6.5 to 60X (optional range 3.5X to 120X)
- Smooth, continuous parfocal zoom
- 9.2:1 zoom ratio
- 23mm photo port (trinocular model only)
- Switch easily between camera and eyepieces (trinocular model only)

DIGITAL HEAD

Digital head with built in 3MP camera and USB output. Easily connect the digital camera directly to a PC for live image viewing and capturing with included Micron software.



BROAD-RANGE ZOOM OPTICS

Broad-Range magnification head with 0.65s to 6X primary magnification range (6.5X to 60X when used with a 10x eyepiece). Its parfocal zoom control delivers crisp, clear images throughout the zoom magnification range. Dual, side-mounted knobs clearly mark the magnification value, and allows the user to quickly identify their magnification.

Optional supplementary lenses and eyepiece alternatives are available to increase or decrease magnification range.

STAND

Sturdy, large low profile base with 10" of vertical height adjustment, and smooth ball-bearing drive focusing mechanism that rides on a continuous gear. It boasts a fully integrated LED illumination system for both upper and lower lighting, and comes with a detachable X/Y mechanical stage for fine movement adjustments to samples at high magnifications.

- 10" of focusing travel on continuous gear
- Sturdy focusing mechanism with no side-to-side movement (sturdier than pole)
- Smooth focusing travel
- Easily move between small and large size samples
- Textured, non-slip surface
- Large working surface of 218mm x 302mm
- Stable working platform
- Ergonomically contoured, low profile base allows for comfortable arm support

ILLUMINATION

Dual, flexible LED light guides delivery an unprecedented cluster of 24 super bright, cool white LED lights (720cd total), which is comparable to a traditional 150 watt fiber optic illumination. Cool illumination is delivered through two flexible light guides from above, while a 12 watt LED light strip provides cool, homogenized illumination to the bottom of your sample.

- 12-watt LED strip creates a homogenized transmitted illumination
- Dual directional upper light guides produce 720cd of focused LED illumination comparable to a 150 watt fiber optic light source
- Independent variable intensity controls for both upper and lower illumination
- 50,000 hour bulb life



T40-MV2



T40-Z33



T40-Z32

CAT. NO.	HEAD	OBJECTIVES	FOV	MAGNIFICATION	FIXED/ZOOM	EYEPIECES	ILLUMINATION
T40MV2	DIGITAL (3MP)	1.1 - 8.8X	27MM - 7.7MM	11X - 88X (27" monitor)	ZOOM	NA	REFLECTED: LED LIGHT GUIDES TRANSMITTED: LED
T40Z32	BINOC	0.65X - 6.0X	35.38MM - 3.83MM	6.5X - 60X	ZOOM	10X	REFLECTED: LED LIGHT GUIDES TRANSMITTED: LED
T40Z33	TRINOC	0.65X - 6.0X	35.38MM - 3.83MM	6.5X - 60X	ZOOM	10x	REFLECTED: LED LIGHT GUIDES TRANSMITTED: LED



T10 Series **LOW PROFILE REFLECTED BASE**

The T10 Series large, low profile platform makes everyday work, simple and easy. Easily incorporate various types of illumination sources to created accommodate a wide range of application needs. With its continuous vertical gear track, this system can accommodate samples of all shapes and sizes easily and comfortably



KEY FEATURES

- Binocular and trinocular (for camera) options
- Dual diopter adjustments accommodates different eye focal length
- Broad range in magnification from 7x to 45x (optional range 3.5x to 180x)
- Smooth, continuous parfocal zoom
- 6.4:1 zoom ratio
- 23mm photo port (trinocular model only)
- Switch easily between camera and eyepieces (trinocular model only)

STANDARD ZOOM OPTICS

Primary magnification range of 0.7x to 4.5x magnification range (7x to 45x when used with a 10x eyepiece), with expandability to 180x. Its parfocal zoom control delivers crisp, clear images throughout the entire zoom magnification range.

Dual, side-mounted knobs clearly mark the magnification value, and allow the user to quickly identify their magnification.

Optional supplementary lenses and eyepiece alternatives are available to increase or decrease magnification range.

EYEPIECES

10x super-widefield eyepieces with interpupillary and diopter adjustments to correct for user-specific eyesight.

STAND

Sturdy, large low profile base with 10" of vertical height adjustment, and smooth ball-bearing drive focusing mechanism that rides on continuous gear.

- 10" of focusing travel on continuous gear
- Sturdy focusing mechanism with no side-to-side movement
- Textured, non-slip surface
- Large working surface of 218mm x 302mm
- Stable working platform
- Ergonomically contoured, low profile base allows for comfortable arm support
- Easily move between small and large size samples
- Smooth focusing travel



Part Number	T10-MZD3
Head Type	5.6" LCD Video View (640 x 480)
Zoom Range	7x – 45x
Resolution	25µm – 3.8µm
Field of View (FOV)	32.8mm – 5.1mm
Working Distance (WD)	93mm
Zoom Ratio	6.4:1
Software	Micron USB 1.1

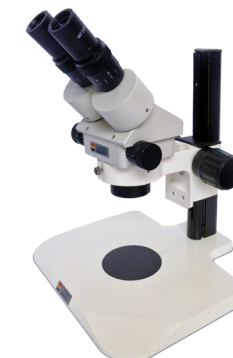

Part Number	T10-MZ22
Head Type	Binocular
Zoom Range	7x – 45x
Resolution	25µm – 3.8µm
Field of View (FOV)	32.8mm – 5.1mm
Working Distance (WD)	93mm
Zoom Ratio	6.4:1
Software	None



Part Number	T10-MZ23
Head Type	Trinocular
Zoom Range	7x – 45x
Resolution	25µm – 3.8µm
Field of View (FOV)	32.8mm – 5.1mm
Working Distance (WD)	93mm
Zoom Ratio	6.4:1
Software	None

CAT. NO.	HEAD	OBJECTIVES	FOV	MAGNIFICATION	FIXED/ZOOM	EYEPIECES	ILLUMINATION
T10MZ22	BINOC	0.7X - 4.5X	32.8MM - 5.1MM	7X - 45X	ZOOM	10X	NA
T10MZ23	TRINOC	0.7X - 4.5X	32.8MM - 5.1MM	7X - 45X	ZOOM	10X	NA
T10MZD3	BINOC + DIGITAL (3MP)	0.7X - 4.5X	32.8MM - 5.1MM	7X - 45X	ZOOM	10x	NA



BM300 Series BOOM STAND

The BM300 Series rugged industrial design is built to last a life-time. With its sturdy, all metal construction, counter balanced horizontal arm, expansive reach, and powerful optics makes this systems design perfect for even the harshest environments. Its booming horizontal reaching arm, rotates a full 360° radius, and boast 17" of vertical and 23" of horizontal movement. With its extensive reach and vertical height, the boom stand can accommodate samples of various sizes and heights. Illumination is delivered via a 150 watt fiber optic ring lamp, which cascades homogenized light down onto large working surface.



STAND

Sturdy, construction with boom arm that reaches out over the sample work surface, and is easily pushed away when not in use. This stand has a 23" extension range with tilting and rotating adjustments. The ball-bearing mechanism will provide a lifetime of smooth, effortless performance. The focus mechanism is a rack-and-pinion system with oversized dual side knobs for comfortable adjustment. The base is heavily weighted and topple-proof even with trinocular models at full extension, and boast a 17" vertical pole to allow adjustments for small to large samples.

- 23" of 360 degree reach
- 17" of vertical height adjustment
- Easily move between small and large size samples
- Focusing mechanism, with smooth ball-bearing rack-and-pinion
- Sturdy steal construction
- Counter balanced horizontal pole

BROAD-RANGE ZOOM OPTICS

Broad-Range magnification head with 0.65s to 6x primary magnification range (6.5x to 60x when used with a 10x eyepiece). Its parfocal zoom control delivers crisp, clear images throughout the zoom magnification range.

Dual, side-mounted knobs clearly mark the magnification value, and allows the user to quickly identify their magnification.

Optional supplementary lenses and eyepiece alternatives are available to increase or decrease magnification range.

ILLUMINATION

Powerful, yet durable, this 21 volt, 150 watt fiber optic illumination boasts a 36" fiber optic ring lamp that attaches securely to the nose cone of the optical head. Light guide securely lock in place with large knurled knob, and can be easily changed out. Its precision dimmer control adjusts illumination in a continuous, smooth, fluid motion creating homogenized, cascading beam of light which illuminates the sample.

- Infrared filter placed directly in front of bulb reduces IR light rays that produce heat at sample
- 36" fiber optic light ring lamp cascades 150 watts of homogenized light down onto large working surface
- Fan cooled and thermal fuse protected
- Heat shield, hinged lid allows for easy access to replacing bulb and protection from bulb heat
- Large knurled knob securely locks light guides in place

SPECIFICATIONS



Part Number	BM300-MV2
Head Type	High-resolution (3MP)
Zoom Range	11x – 357x (27" monitor)
Resolution	100µm – 4.2µm
Field of View (FOV)	54mm – 1.68mm
Working Distance (WD)	143mm – 20mm
Zoom Ratio	32:1
Software	Micron USB 2.0



Part Number	BM300-Z32
Head Type	Binocular
Zoom Range	6.5x – 60x
Resolution	25µm – 4µm
Field of View (FOV)	35.38 – 3.83mm
Working Distance (WD)	110mm
Zoom Ratio	9:2:1
Software	None

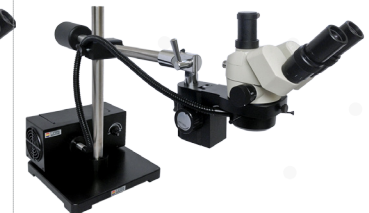

Part Number	BM300-Z33
Head Type	Trinocular
Zoom Range	6.5x – 60x
Resolution	25µm – 4µm
Field of View (FOV)	35.38 – 3.83mm
Working Distance (WD)	110mm
Zoom Ratio	9:2:1
Software	None

CAT. NO.	HEAD	OBJECTIVES	AUX. LENS	MAGNIFICATION	FIXED/ZOOM	EYEPIECES	ILLUMINATION
BM300MV2	DIGITAL (3MP)	1.1X - 35.7X	0.5X/1X/2X	11X - 357X (27" monitor)	ZOOM	NA	REFLECTED: 150W FIBER OPTIC ILLUMINATOR WITH RING LAMP
BM300Z32	TRINOC	0.65x-6x	NA	6.5X - 60X	ZOOM	10X	REFLECTED: 150W FIBER OPTIC ILLUMINATOR WITH RING LAMP
BM300Z33	TRINOC	0.65x-6x	NA	6.5X - 60X	ZOOM	10x	REFLECTED: 150W FIBER OPTIC ILLUMINATOR WITH RING LAMP



BM500 Series DUAL HEAD BOOM STAND

The BM500 Series rugged industrial design is built to last a life-time. With its sturdy, all metal construction, counter balanced horizontal arm, expansive reach, and powerful optics makes this systems design perfect for even the harshest environments. Its booming horizontal reaching arm, rotates a full 360° radius, and boasts 17” of vertical and 23” of horizontal movement. With its extensive reach and vertical height, the boom stand can accommodate samples of various sizes and heights. Illumination is delivered via a 150 watt equivalent LED illumination directly built into the focusing mechanism, which cascades homogenized light down onto large working surface.

Dual view heads allows for multiple users to view the same FOV’s for surgical procedures or teaching.

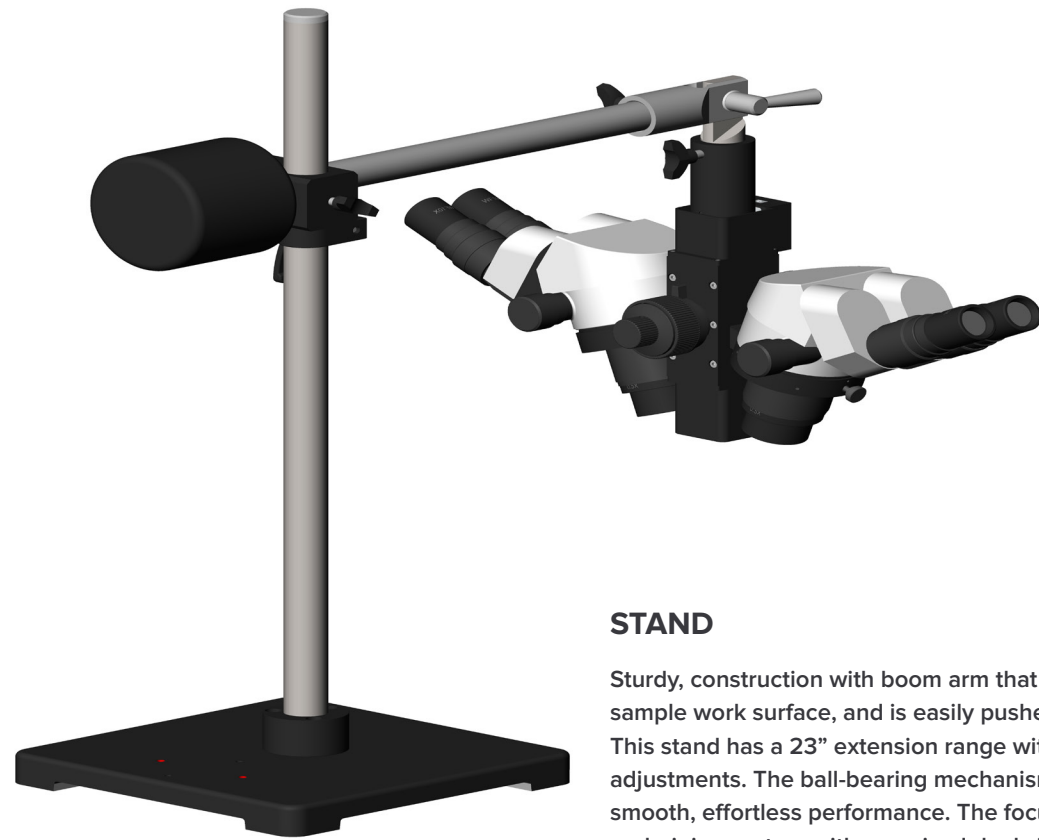

STAND

Sturdy, construction with boom arm that reaches out over the sample work surface, and is easily pushed away when not in use. This stand has a 23” extension range with tilting and rotating adjustments. The ball-bearing mechanism will provide a lifetime of smooth, effortless performance. The focus mechanism is a rack-and-pinion system with oversized dual side knobs for comfortable adjustment. The base is heavily weighted and topple-proof even at full extension, and is mounted on a 17” vertical pole to allow adjustments for small to large samples.

- 23” of 360 degree reach
- 17” of vertical height adjustment
- Easily move between small and large size samples
- Focusing mechanism, with smooth ball-bearing rack-and-pinion
- Sturdy steal construction
- Counter balanced horizontal pole

BROAD-RANGE ZOOM OPTICS (BM500MZ32D)

Broad-Range magnification head with 0.65s to 6x primary magnification range (6.5x to 60x when used with a 10x eyepiece). Its parfocal zoom control delivers crisp, clear images throughout the zoom magnification range.

Dual, side-mounted knobs clearly mark the magnification value, and allows the user to quickly identify their magnification.

Optional supplementary lenses and eyepiece alternatives are available to increase or decrease magnification range.



STANDARD ZOOM OPTICS (BM500MZ22D)

Primary magnification range of 0.7x to 4.5x magnification range (7x to 45x when used with a 10x eyepiece), with expandability to 180x. Its parfocal zoom control delivers crisp, clear images throughout the entire zoom magnification range.

Dual, side-mounted knobs clearly mark the magnification value, and allow the user to quickly identify their magnification.



Part Number BM500-MZ22-D
Head Type Binocular



Part Number BM500-MZ32-D
Head Type Binocular

Zoom Range 7x – 45x
Resolution 25µm – 3.8µm
Field of View (FOV) 32.8mm – 5.1mm
Working Distance (WD) 93mm
Zoom Ratio 6.4:1

Zoom Range 6.5x – 60x
Resolution 25µm – 4µm
Field of View (FOV) 35.38 – 3.83mm
Working Distance (WD) 110mm
Zoom Ratio 9:2:1

CAT. NO.	HEAD	OBJECTIVES	AUX. LENS	MAGNIFICATION	FIXED/ZOOM	EYEPIECES	ILLUMINATION
BM500MZ22D	BINOC	0.7X - 4.5X	NA	7X - 45X	ZOOM	10X	REFLECTED: LED (150W EQUIVALENT)
BM500MZ32D	BINOC	0.65x-6x	NA	6.5X - 60X	ZOOM	10X	REFLECTED: LED (150W EQUIVALENT)



A10 Series **ARM STAND**

The A10 series design allows for the most versatility in the movement range for those applications where the optics need to be moved over the specimen in practically every conceivable position. Both vertical and horizontal reach all nearly any size object to be viewed; big or small. The smooth, gliding arm articulates in a full 360° radius, with both vertical and horizontal movement. With its 150 watt fiber optic illuminator, light cascades down onto the working surface, illuminating a large, homogenized area. With a wide range of optics, this system is both versatile and adaptable to any application.

BROAD RANGE ZOOM OPTICS

Broad-Range magnification head with 0.65s to 6x primary magnification range (6.5x to 60x when used with a 10x eyepiece). Its parfocal zoom control delivers crisp, clear images throughout the zoom magnification range.

Dual, side-mounted knobs clearly mark the magnification value, and allows the user to quickly identify their magnification.

Optional supplementary lenses and eyepiece alternatives are available to increase or decrease magnification range.

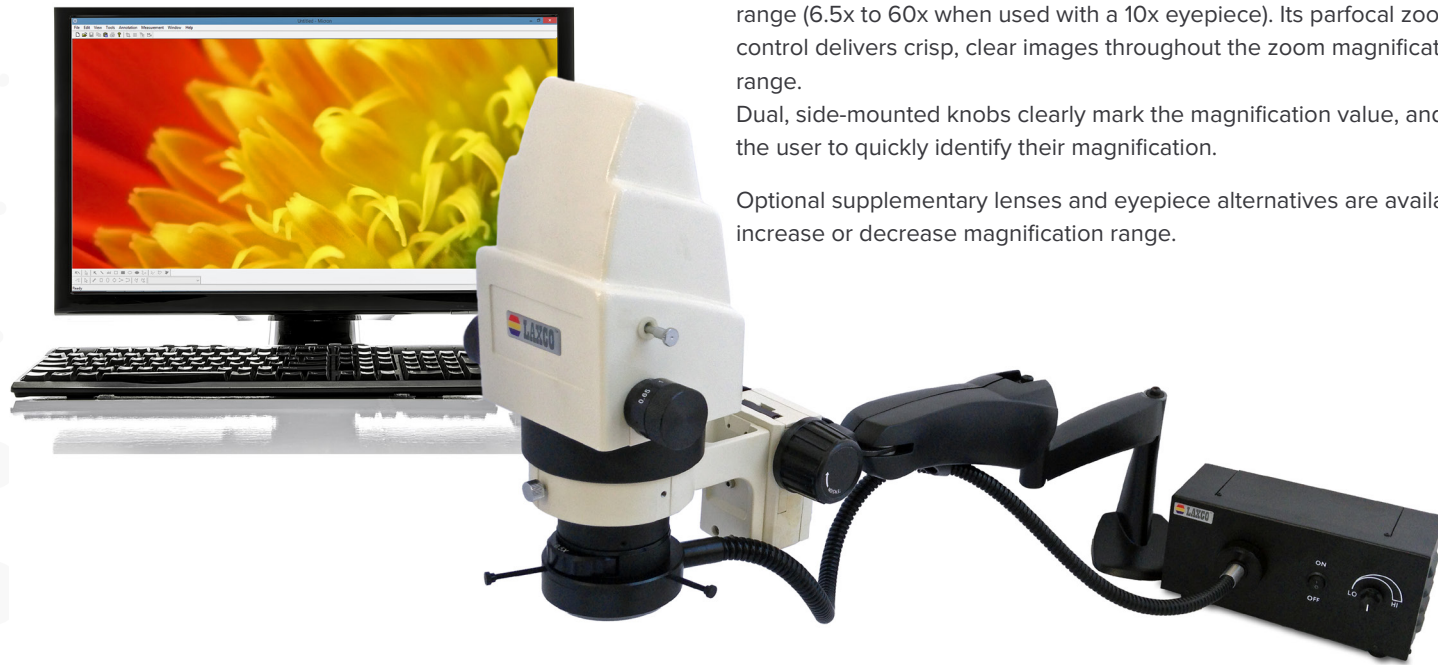

ILLUMINATION

Powerful, yet durable, this 21 volt, 150 watt fiber optic illumination boasts a 36" fiber optic ring lamp that attaches securely to the nose cone of the optical head. Light guide securely lock in place with large knurled knob, and can be easily changed out. Its precision dimmer control adjusts illumination in a continuous, smooth, fluid motion creating homogenized, cascading beam of light which illuminates the sample.

- Infrared filter placed directly in front of bulb reduces IR light rays that produce heat at sample
- Adjustable focusing lens focuses 150 watts of illumination to a fine point, or broaden it to be a flood
- Fan cooled and thermal fuse protected

STAND

Pneumatic arm rotates 360° with an impressive 11" reach to easily maneuver over a large surface area. The arm is able to reach 9" vertically, and has an adjustable counterbalanced to maintain support. The 5.52" adjustable clamp attaches to most standard bench tops.

- Smooth, fluid movement
- Impressive 10.8" (275mm) reach
- Reaches 9.38" (238.25mm) in vertical height
- Clamps onto surfaces up to 2.99" (76mm) thick
- Pneumatic arm to easily adjust height

SPECIFICATIONS



Part Number	A10-MV2
Head Type	High-resolution (3MP)
Zoom Range	11x – 357x (27" monitor)
Resolution	100µm – 4.2µm
Field of View (FOV)	54mm – 1.68mm
Working Distance (WD)	143mm – 20mm
Zoom Ratio	32:1
Software	Micron USB 2.0



Part Number	A10-Z33
Head Type	Trinocular
Zoom Range	6.5x – 60x
Resolution	25µm – 4µm
Field of View (FOV)	35.38 – 3.83mm
Working Distance (WD)	110mm
Zoom Ratio	9:2:1
Software	None



Part Number	A10-Z32
Head Type	Binocular
Zoom Range	6.5x – 60x
Resolution	25µm – 4µm
Field of View (FOV)	35.38 – 3.83mm
Working Distance (WD)	110mm
Zoom Ratio	9:2:1
Software	None

CAT. NO.	HEAD	OBJECTIVES	AUX. LENS	MAGNIFICATION	FIXED/ZOOM	EYEPIECES	ILLUMINATION
A10MV2	DIGITAL (3MP)	1.1X - 35.7X	0.5X/1X/2X	11X - 357X (27" monitor)	ZOOM	NA	REFLECTED: 150W FIBER OPTIC ILLUMINATOR WITH RING LAMP
A10Z32	BINOC	0.65X - 6.0X	NA	6.5X - 60X	ZOOM	10X	REFLECTED: 150W FIBER OPTIC ILLUMINATOR WITH RING LAMP
A10Z33	TRINOC	0.65X - 6.0X	NA	6.5X 60X	ZOOM	10x	REFLECTED: 150W FIBER OPTIC ILLUMINATOR WITH RING LAMP



MZS4 Series TRANSMITTED LED MIRROR STAND

The MZS4 series combines a traditional design with a tilting mirror and high powered LED illumination. It's all metal construction gives the stand the ruggedness, while its precision optics, deliver crisp clear images throughout a continuous zoom range. Independently controlled, dual halogen illumination shines homogenized light from above and below the sample and the oversized dual focus knobs allows for both left and right hand operation.

BROAD-RANGE ZOOM OPTICS (MZS432/33)

Broad-Range magnification head with 0.65s to 6x primary magnification range (6.5x to 60x when used with a 10x eyepiece). Its parfocal zoom control delivers crisp, clear images throughout the zoom magnification range.

Dual, side-mounted knobs clearly mark the magnification value, and allows the user to quickly identify their magnification.

Optional supplementary lenses and eyepiece alternatives are available to increase or decrease magnification range.



Part Number	MZS4-Z32
Head Type	Binocular
Zoom Range	6.5x – 60x
Resolution	25µm – 4µm
Field of View (FOV)	35.38 – 3.83mm
Working Distance (WD)	110mm
Zoom Ratio	9:2:1
Software	None



Part Number	MZS4-Z33
Head Type	Trinocular
Zoom Range	6.5x – 60x
Resolution	25µm – 4µm
Field of View (FOV)	35.38 – 3.83mm
Working Distance (WD)	110mm
Zoom Ratio	9:2:1
Software	None

STAND

Traditional design and rugged stand is built to last a life-time. Its wide base, and oversized dual focus knobs for left and right hand operation allow for easy operation.

- Rugged, all metal construction
- Large, contoured stage
- Left and right hand operation

ILLUMINATION

Transmitted LED with tilting mirror and removable diffuser allows for complete adjustment of illumination and contrast.

STANDARD ZOOM OPTICS (MZS422/23/D3)

Primary magnification range of 0.7x to 4.5x magnification range (7x to 45x when used with a 10x eyepiece), with expandability to 180x. Its parfocal zoom control delivers crisp, clear images throughout the entire zoom magnification range.

Dual, side-mounted knobs clearly mark the magnification value, and allow the user to quickly identify their magnification.



Part Number	MZS4-MZD3
Head Type	Digital 3MP Camera
Zoom Range	7x – 45x
Resolution	25µm – 3.8µm
Field of View (FOV)	32.8mm – 5.1mm
Working Distance (WD)	93mm
Zoom Ratio	6.4:1
Software	Micron



Part Number	MZS4-MZ22
Head Type	Binocular
Zoom Range	7x – 45x
Resolution	25µm – 3.8µm
Field of View (FOV)	32.8mm – 5.1mm
Working Distance (WD)	93mm
Zoom Ratio	6.4:1
Software	None



Part Number	MZS4-MZ23
Head Type	Trinocular
Zoom Range	7x – 45x
Resolution	25µm – 3.8µm
Field of View (FOV)	32.8mm – 5.1mm
Working Distance (WD)	93mm
Zoom Ratio	6.4:1
Software	None

CAT. NO.	HEAD	OBJECTIVES	AUX. LENS	MAGNIFICATION	FIXED/ZOOM	EYEPIECES	ILLUMINATION
MZS422	BINOC	0.7X - 4.5X	NA	7X - 45X	ZOOM	10x	TRANSMITTED: LED WITH TILTING MIRROR
MZS423	TRINOC	0.7X - 4.5X	NA	7X - 45X	ZOOM	10X	TRANSMITTED: LED WITH TILTING MIRROR
MZS432	TRINOC	0.65X - 6X	NA	6.5X - 60X	ZOOM	10x	TRANSMITTED: LED WITH TILTING MIRROR
MZS433	TRINOC	0.65X - 6X	NA	6.5X - 60X	ZOOM	20X	TRANSMITTED: LED WITH TILTING MIRROR
MZS4D3	BINOC	0.7X - 4.5X	NA	6.5X - 60X	ZOOM	10x	TRANSMITTED: LED WITH TILTING MIRROR



MZS32 Series **ADVANCED ILLUMINATION STAND**

Laxco's MZS32 Series combines advanced contrast methods to deliver brilliant resolution for a wide range of sample types. Available illumination techniques include transmitted LED, Darkfield and removable dual LED light guides. A touch panel conveniently located on the front of the microscope provides easy control of all available illumination.

BROAD-RANGE ZOOM OPTICS

Broad-Range magnification head with 0.65s to 6x primary magnification range (6.5x to 60x when used with a 10x eyepiece). Its parfocal zoom control delivers crisp, clear images throughout the zoom magnification range.

Dual, side-mounted knobs clearly mark the magnification value, and allows the user to quickly identify their magnification.

Optional supplementary lenses and eyepiece alternatives are available to increase or decrease magnification range.

STAND

The innovative design of the MZS32 stand provides a wide variety of illumination techniques all incorporated in a low profile stage design. This is our most advanced stand and easily allows you to upgrade the stand as your needs change.

- Diascopic transmitted illumination for contrast of transparent samples
- Recessed opening for up to 100mm size petri dishes for darkfield illumination
- Floating stage to move sample around in Darkfield well
- Capacitive touch light control panel allows for easy switch between light techniques and brightness control
- 10" of focusing travel on continuous gear
- Sturdy focusing mechanism with no side-to-side movement
- Textured, non-slip surface
- Large working surface of 218mm x 302mm
- Stable working platform
- Ergonomically contoured, low profile base allows for comfortable arm support
- Easily move between small and large size samples
- Smooth focusing travel



ILLUMINATION

- Removable, dual LED light guides with available interchangeable wavelength specific LED's
- Interchangeable nose piece allows for optional LED ring lamp
- 120 Watt equivalent LED transmitted ring creates homogenized brightness through field of view
- Individual 50 Watt equivalent, dual light guides for bi-directional illumination adjustment

SPECIFICATIONS



Part Number	MZS32322
Head Type	Binocular
Zoom Range	6.5x – 60x
Resolution	25µm – 4µm
Field of View (FOV)	35.38 – 3.83mm
Working Distance (WD)	110mm
Zoom Ratio	9:2:1
Software	None
Aux Lens	NA



Part Number	MZS32321
Head Type	Binocular
Zoom Range	6.5x – 60x
Resolution	25µm – 4µm
Field of View (FOV)	35.38 – 3.83mm
Working Distance (WD)	110mm
Zoom Ratio	9:2:1
Software	None
Aux Lens	0.5x

Part Number	MZS32333
Head Type	Trinocular
Zoom Range	6.5x – 60x
Resolution	25µm – 4µm
Field of View (FOV)	35.38 – 3.83mm
Working Distance (WD)	110mm
Zoom Ratio	9:2:1
Software	None
Aux Lens	NA

Part Number	MZS32331
Head Type	Trinocular
Zoom Range	6.5x – 60x
Resolution	25µm – 4µm
Field of View (FOV)	35.38 – 3.83mm
Working Distance (WD)	110mm
Zoom Ratio	9:2:1
Software	None
Aux Lens	0.5x

CAT. NO.	HEAD	OBJECTIVES	AUX. LENS	MAGNIFICATION	FIXED/ZOOM	EYEPIECES	ILLUMINATION
MZS32322	BINOC	0.65x - 6.0x	NA	6.5X - 60X	ZOOM	10x	REFLECTED: DUAL LED LIGHT GUIDES TRANSMITTED: LED TRANSMITTED DARKFIELD: LED
MZS32321	BINOC	0.65x - 6.0x	0.5X	3.2x - 30x	ZOOM	10X	REFLECTED: DUAL LED LIGHT GUIDES TRANSMITTED: LED TRANSMITTED DARKFIELD: LED
MZS32333	TRINOC	0.65x - 6.0x	NA	6.5X - 60X	ZOOM	10x	REFLECTED: DUAL LED LIGHT GUIDES TRANSMITTED: LED TRANSMITTED DARKFIELD: LED
MZS32331	TRINOC	0.65x - 6.0x	0.5X	3.2x - 30x	ZOOM	10X	REFLECTED: DUAL LED LIGHT GUIDES TRANSMITTED: LED TRANSMITTED DARKFIELD: LED

MZS33 Series

ADVANCED ILLUMINATION STAND WITH FLUORESCENCE



Laxco's MZS33 Series Stand incorporates all of the features of the MZS32 and also include an LED Fluorescence ring lamp for fluorescence application. Available illumination techniques include LED fluorescence ring lamp, transmitted LED, Darkfield and removable dual LED light guides. A touch panel conveniently located on the front of the microscope provides easy control of all available illumination.

BROAD-RANGE ZOOM OPTICS

Broad-Range magnification head with 0.65s to 6x primary magnification range (6.5x to 60x when used with a 10x eyepiece). Its parfocal zoom control delivers crisp, clear images throughout the zoom magnification range.

Dual, side-mounted knobs clearly mark the magnification value, and allows the user to quickly identify their magnification.

Optional supplementary lenses and eyepiece alternatives are available to increase or decrease magnification range.

STAND

The innovative design of the MZS32 stand provides a wide variety of illumination techniques all incorporated in a low profile stage design. This is our most advanced stand and easily allows you to upgrade the stand as your needs change.

- Diascopic transmitted illumination for contrast of transparent samples
- Recessed opening for up to 100mm size petri dishes for darkfield illumination
- Floating stage to move sample around in Darkfield well
- Capacitive touch light control panel allows for easy switch between light techniques and brightness control
- 10" of focusing travel on continuous gear
- Sturdy focusing mechanism with no side-to-side movement
- Textured, non-slip surface
- Large working surface of 218mm x 302mm
- Stable working platform
- Ergonomically contoured, low profile base allows for comfortable arm support
- Easily move between small and large size samples
- Smooth focusing travel



ILLUMINATION

- 120 Watt equivalent, wavelength specific, LED transmitted ring illuminator for fluorescence excitation. Includes filter slot for EM filter
- Removable, dual LED light guides with available interchangeable wavelength specific LED's
- Interchangeable nose piece allows for optional LED ring lamp
- 120 Watt equivalent LED transmitted ring creates homogenized brightness through field of view

SPECIFICATIONS



Part Number	MZS3333DGR/DAPI/GFP/RFP
Head Type	Trinocular
Zoom Range	6.5x – 60x
Resolution	25µm – 4µm
Field of View (FOV)	35.38 – 3.83mm
Working Distance (WD)	110mm
Zoom Ratio	9:2:1
Software	None
Aux Lens	NA

CAT. NO.	HEAD	OBJECTIVES	FL CHANNELS	MAGNIFICATION	FIXED/ZOOM	EYEPIECES	ILLUMINATION
MZS3333DGR	TRINOC	0.65x - 6.0x	GFP, RFP, DAPI	6.5X - 60X	ZOOM	10x	FLUORESCENCE: 120W EQUIVALENT LED RING LAMP (WAVELENGTH SPECIFIC) REFLECTED: DUAL LED LIGHT GUIDES TRANSMITTED: LED TRANSMITTED DARKFIELD: LED
MZS3333DAPI	TRINOC	0.65x - 6.0x	DAPI	3.2x - 30x	ZOOM	10X	FLUORESCENCE: 120W EQUIVALENT LED RING LAMP (WAVELENGTH SPECIFIC) REFLECTED: DUAL LED LIGHT GUIDES TRANSMITTED: LED TRANSMITTED DARKFIELD: LED
MZS3333GFP	TRINOC	0.65x - 6.0x	GFP	6.5X - 60X	ZOOM	10x	FLUORESCENCE: 120W EQUIVALENT LED RING LAMP (WAVELENGTH SPECIFIC) REFLECTED: DUAL LED LIGHT GUIDES TRANSMITTED: LED TRANSMITTED DARKFIELD: LED
MZS3333RFP	TRINOC	0.65x - 6.0x	RFP	3.2x - 30x	ZOOM	10X	FLUORESCENCE: 120W EQUIVALENT LED RING LAMP (WAVELENGTH SPECIFIC) REFLECTED: DUAL LED LIGHT GUIDES TRANSMITTED: LED TRANSMITTED DARKFIELD: LED



Illumination Systems

LIGHT SOURCES

FIBER OPTIC LIGHT SOURCE

Powerful, yet durable, this 21 volt, 150 watt fiber optic illumination boasts multiple light guide option to include: a 36" fiber optic ring lamp, 23" bifurcated light guide, and single 23" light guide. Light guide securely lock in place with large knurled knob, and can be easily changed out. Its precision dimmer control adjusts illumination in a continuous, smooth, fluid motion creating homogenized, cascading beam of light which illuminates the sample.

- Infrared filter placed directly in front of bulb reduces IR light rays that produce heat at sample
- Adjustable focusing lens focuses 150 watts of illumination to a fine point, or broaden it to be a flood for (single and bifurcated options only)
- 36" fiber optic ring lamp that attaches to nose cone of stereo head
- Fan cooled and thermal fuse protected
- Heat shield, hinged lid allows for easy access to replacing bulb and protection from bulb heat
- Large knurled knob securely locks light guides in place



Accessories

Part Number	Description
PI-FOS150	150 watt fiber optic light source (guides required for use)
FOG-S23	Fiber optic single light guide
FOG-B23	Fiber optic dual (bifurcated) light guide
FOG-R36	Fiber optic ring light guide



Part Number	PI-FOS150-IB
Lamp	Halogen
Wattage	150 Watts
Guide Type	Bifurcated Light Guide



Part Number	PI-FOS150-R
Lamp	Halogen
Wattage	150 Watts
Guide Type	Ring Lamp



Part Number	PI-FOS150-S
Lamp	Halogen
Wattage	150 Watts
Guide Type	Single Light Guide

LED LIGHT SOURCE

Dual, flexible LED light guides deliver an unprecedented cluster of 24 super bright, cool white LED lights (720cd total), which is comparable to a traditional 150 watt fiber optic illumination. Cool illumination is delivered through two flexible light guides from above, while a 12 watt LED light strip provides cool, homogenized illumination to the bottom of your sample.

- 12-watt LED strip creates a homogenized transmitted illumination
- Dual directional upper light guides produce 720 cd of focused LED illumination comparable to a 150 watt fiber optic light source
- Independent variable intensity controls
- 50,000 hour bulb life
- Bracket available to attach light source directly to microscope



Part Number	AMPS-ILED-21
Lamp	LED
Wattage	720 cd
Base	Weighted



Part Number	AMPS-ILED-22
Lamp	LED
Wattage	720 cd
Base	Clamp



Part Number	AMPS-ILED-23
Lamp	LED
Wattage	720 cd
Base	Weighted
Battery Pack	Included



© 2016 Thermo Fisher Scientific Inc. All rights reserved.
Trademarks used are owned as indicated at www.fishersci.com/trademarks.

In the United States:

For customer service, call 1-800-766-7000
To fax an order, use 1-800-926-1166
To order online: www.fishersci.com

BN1010164

In Canada:

For customer service, call 1-800-234-7437
To fax an order, use 1-800-463-2996
To order online: www.fishersci.ca



A Thermo Fisher Scientific Brand